

# Control and Signaling Diameter 22mm **XB5 / ZB5**

Catalog  
February  
**2004**

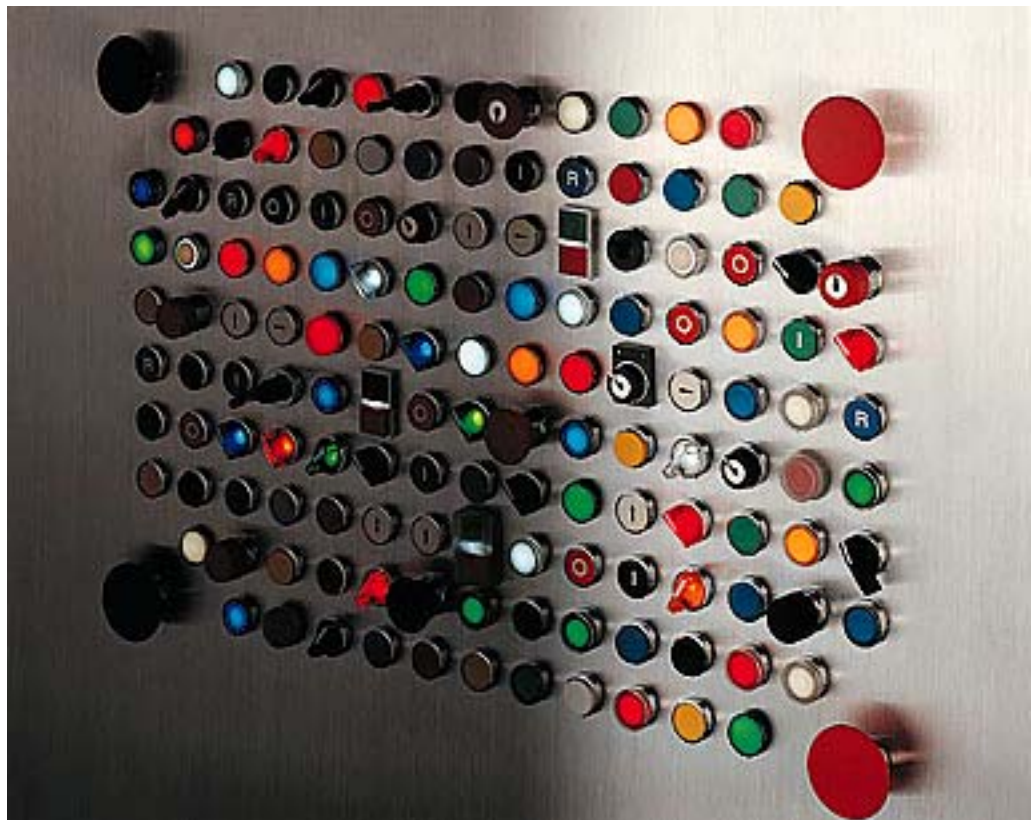

# Control and signalling units Ø 22

Harmony® style 5

Pushbuttons, switches and pilot lights with double insulated bezel

Complete units, XB5 A

## Complete units

## Contact functions

### Pushbuttons, spring return

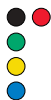

#### Flush push

[XB5 AA•1/AA42](#)  
see page 36012/2

[XB5 AA3311/AA33•1](#)  
see page 36012/2

[XB5 AA4322](#)  
see page 36012/2

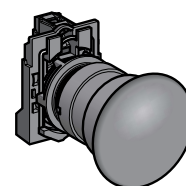

#### Booted flush push

[XB5 AP•1/AP42](#)  
see page 36012/2

#### Projecting push

[XB5 AL42](#)  
see page 36012/2

#### Mushroom head

[XB5 AC21](#)  
see page 36012/2

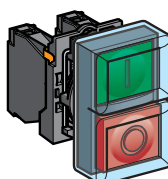
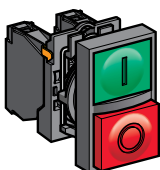

### Double-headed pushbuttons, spring return

#### Flush push + projecting push

[XB5 AL845](#)  
see page 36012/2

#### Booted flush push + projecting push

[XB5 AL945](#)  
see page 36012/2

### Ø 40 Emergency stop mushroom head pushbuttons with or without trigger action

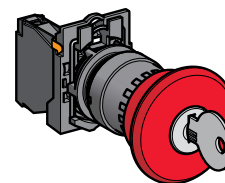
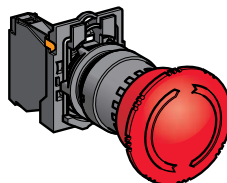
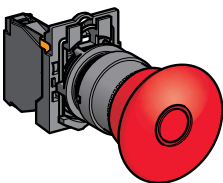

#### Push-pull

[XB5 AT42/AT845](#)  
see page 36012/3

#### Turn to release

[XB5 AS542/AS8445](#)  
see page 36012/3

#### Key release

[XB5 AS142/AS9445](#)  
see page 36012/3

### Selector switches and key switches



#### Standard black handle

[XB5 AD](#)  
see page 36012/3

#### Long black handle

[XB5 AJ](#)  
see page 36012/3

#### Key switch

[XB5 AG](#)  
see page 36012/3

### Complete units

(continued)

#### Pilot lights

### Signalling functions

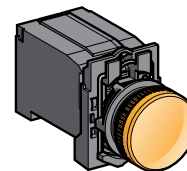
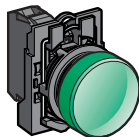

With integral LED

**XB5 AVB/AVG/AVM**  
see page 36013/2

For BA 9s bulb  
Direct supply

**XB5 AV**  
see page 36013/3

Via integral transformer

**XB5 AV3/AV4**  
see page 36013/3

### Combined functions (contact + signalling)

#### Illuminated pushbuttons, spring return, flush push

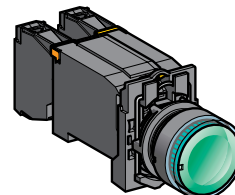

With integral LED

**XB5 AW3•B6/AW3•G5/AW3•M5**  
see page 36014/2

For BA 9s bulb  
Direct supply

**XB5 AW3•65**  
see page 36014/2

Via integral transformer

**XB5 AW3•35/AW3•45**  
see page 36014/2

#### Double-headed pushbuttons, spring return, with pilot light

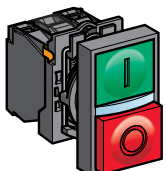

With integral LED

**XB5 AW84•5**  
see page 36014/3

#### Illuminated selector switches, standard handle

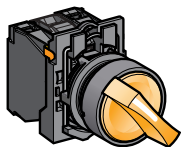

With integral LED

**XB5 AK12•B5/AK12•G5/BK12•M5**  
see page 36014/3

# Control and signalling units Ø 22

Harmony® style 5

Pushbuttons, switches and pilot lights with double insulated bezel

Sub-assemblies, ZB5 A

**Non illuminated units for user assembly**

**Contact functions**

**Body sub-assemblies**

**Head sub-assemblies**

For pushbuttons, spring return, without marking

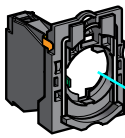

Screw clamp terminals  
ZB5 AZ10/AZ141  
see page 36015/2

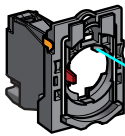

Plug-in connector  
ZB5 AZ10/AZ141  
see page 36015/2

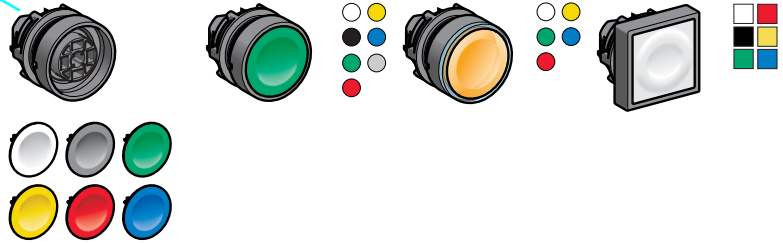

Flush push with cap mounted or not mounted ZB5 AA0/AA9 see page 36015/3	Flush push ZB5 AA see page 36015/3	Flush push for insertion of legend ZB5 AA8 see page 36015/3	Flush push ZB5 CA see page 36015/5
---	--	---	--



Projecting push ZB5 AL see page 36015/3	Recessed push ZB5 AA see page 36015/3	Booted flush push ZB5 AP/AP8 see page 36015/3	Projecting push ZB5 CL see page 36015/3
---	---	---	---

For pushbuttons, spring return, with marking



Flush push ZB5 AA3/AA4 see page 36015/4	Projecting push ZB5 AL see page 36015/4	Flush push ZB5 CA3/CA9 see page 36015/4
---	---	---

For "push-turn to release" pushbuttons

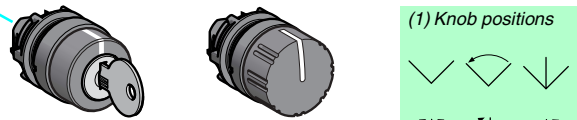

Key switch ZB5 AFD see page 36015/4	Knurled knob (1) ZB5 AF see page 36015/4
---	--

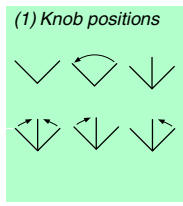

For double-headed pushbuttons, spring return

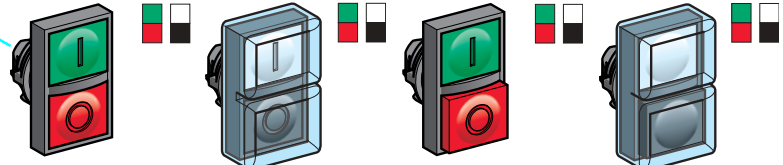

Flush pushes (IP 40/IP 66) Without/with marking ZB5 AA81/AA82 see page 36015/5	Flush pushes (IP 40/IP 66) Without/with marking ZB5 AA91/AA92 see page 36015/5	Flush push + projecting push (IP 40/IP 66) Without/with marking ZB5 AL83/AL84 see page 36015/5	Flush push + projecting push (IP 40/IP 66) Without/with marking ZB5 AL93/AL94 see page 36015/5
--	--	--	--

For "push-push to release" pushbuttons



Flush push ZB5 AH0/CH0 see page 36015/5	Projecting push ZB5 AH see page 36015/5	Flush push ZB5 CH0 see page 36015/5
---	---	---

# Control and signalling units Ø 22

## Harmony® style 5

Pushbuttons, switches and pilot lights with double insulated bezel

Sub-assemblies, ZB5 A

### Non illuminated units for user assembly

(continued)

### Contact functions (continued)

#### Body sub-assemblies

#### Head sub-assemblies

For mushroom head pushbuttons, spring return

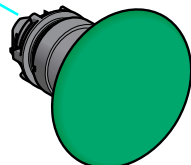
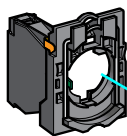

- ●
- ●
- ●
- Ø 30
- Ø 40
- Ø 60

Screw clamp terminals

ZB5 AZ10●/AZ141  
see page 36015/2

Spring return

ZB5 AC/AR  
see page 36015/6

For mushroom head pushbuttons, latching, with or without trigger action

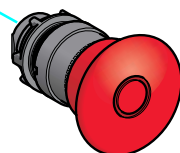
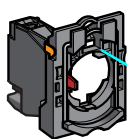

- ●
- ●
- Ø 30
- Ø 40
- Ø 60

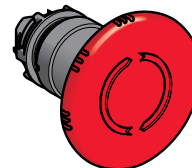

- ●
- ●
- Ø 30
- Ø 40
- Ø 60

Plug-in connector

ZB5 AZ10●/AZ141  
see page 36015/2

Push-pull

ZB5 AT84/AT●/AX●  
see page 36015/7

Turn to release

ZB5 AS8●/AS4●/ AS5●/AS6●  
see page 36015/7

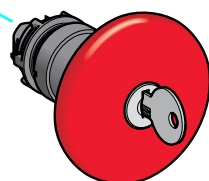

- ●
- ●
- Ø 30
- Ø 40
- Ø 60

Key release

ZB5 AS9●/AS7●/AS1●/AS2●  
see page 36015/7

For selector switches and key switches



Standard handle (1)

ZB5 AD●  
see page 36015/8

Long black handle (1)

ZB5 AJ●  
see page 36015/9



Knurled black knob (1)

ZB5 AD●9  
see page 36015/10



Key switch (2)

ZB5 AG●/AG0●  
see page 36015/11

(1) Switch handle and knob positions



(2) Key switch positions  
⌘ Key withdrawal positions

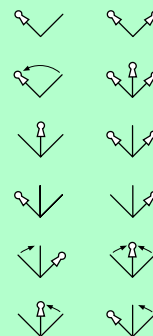

For toggle switches



2-position

ZB5 AD●8  
see page 36016/11

### Pilot lights for user assembly

### Signalling functions

#### Body sub-assemblies with integral LED

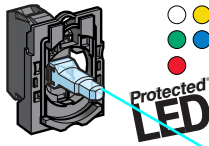

Screw clamp terminals  
ZB5 AVB/AVG/AVM  
see page 36016/2

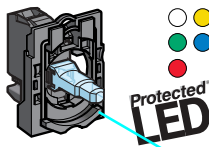

Plug-in connector  
ZB5 AVB4/AVG4/AVM4  
see page 36016/2

#### Head sub-assemblies



With lens mounted  
ZB5 AV03  
see page 36016/3

ZB5 CV03  
see page 36016/3

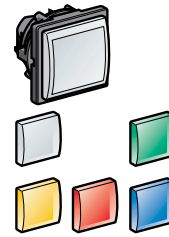

With 5 separate lenses not mounted  
ZB5 AV003  
see page 36016/3

ZB5 CV003  
see page 36016/3

#### Body sub-assemblies for BA 9s bulb



Direct supply  
Screwclamp terminals  
ZB5 AV6  
see page 36016/3

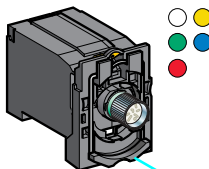

Via integral transformer  
Screw clamp terminals  
ZB5 AV0/AV3D0/AV5D0  
see page 36016/3

#### Head sub-assemblies



With lens mounted  
ZB5 AV06  
see page 36016/3

# Control and signalling units Ø 22

## Harmony® style 5

Pushbuttons, switches and pilot lights with double insulated bezel

Sub-assemblies, ZB5 A

### Illuminated pushbuttons for user assembly

For illuminated push-buttons, spring return

### Combined functions (contact + signalling)

#### Body sub-assemblies with integral LED

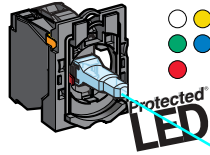

Screw clamp terminals  
ZB5 AW0B/AW0G/AW0M see pages 36017/4 and 36025/3

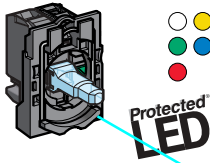

Plug-in connector  
ZB5 AW0B/AW0G/AW0M see pages 36017/4 and 36026/3

For double-headed pushbuttons, spring return, with pilot light

For illuminated "push-push to release" push-buttons and illuminated selector switches with standard handle

#### Body sub-assemblies for BA9s bulb

For illuminated push-buttons, spring return

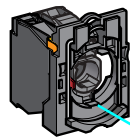

Direct supply  
Screw clamp terminals  
ZB5 AW06 see page 36017/6

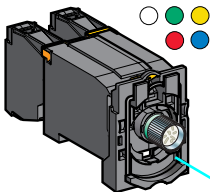

Via integral transformer  
Screw clamp terminals  
ZB5 AW03/4/5/3D/5D see page 36017/6

#### Head sub-assemblies



Flush push with cap mounted/not mounted  
ZB5 AW3/AW9 see page 36017/7

Flush push for insertion of legend  
ZB5 AA see page 36017/7

Booted flush push  
ZB5 AW5 see page 36017/7

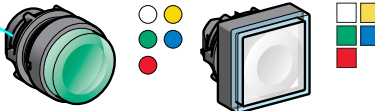

Projecting push  
ZB5 AW1/AL see page 36017/7

Flush or projecting push  
ZB5 CW3/CW1 see page 36017/7

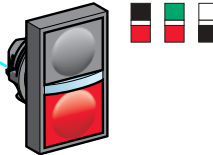

Flush push Without/with markings  
ZB5 AW81 see page 36017/8

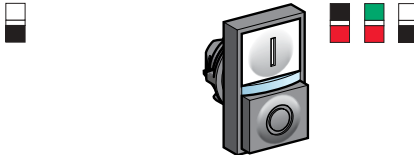

Flush push + projecting push Without/with markings  
ZB5 AW82 see page 36017/8  
ZB5 AW83 see page 36017/8  
ZB5 AW84 see page 36017/8

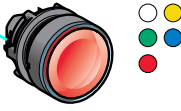

Flush or projecting "push-push to release"  
ZB5 AH0/3/AH see page 36017/8



Standard handle operator  
ZB5 AK1 see page 36017/9

#### Head sub-assemblies



Flush push  
ZB5 AW3 see page 36017/7

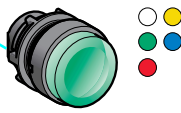

Projecting push  
ZB5 AW1 see page 36017/7

Environment			
Protective treatment standard version			"TH"
Ambient air temperature around the device	Storage	°C	- 40...+ 70
	Operation	°C	- 25...+ 70 unless otherwise stated
Electric shock protection	Conforming to IEC 60536		Class II
Degree of protection	Conforming to IEC 60529		IP 65, unless otherwise stated IP 66, for booted pushbutton heads
	Conforming to NEMA		NEMA type 4X and 13, unless otherwise stated
Resistance to high pressure washer		Pa	70 x 10 <sup>5</sup> (70 bar); distance: 0.1 m Temperature: 55°C
Mechanical shock protection	Conforming to IEC 50102		Non illuminated heads: IK 03
			Illuminated heads: IK 05
Conforming to standards			IEC/EN 60947-1, IEC/EN 60947-5-1, IEC/EN 60947-5-4, JIS C 4520, UL 508, CSA C22-2 n° 14
Product certifications	UL Listed, CSA		Standard single contact blocks with screw clamp terminals: A600; Q600 Double contact blocks with screw clamp terminals: A600; Q600 Light blocks with screw clamp terminals Joystick controllers XD5 PA/ZD5 PA: A600; R300
	UL Recognized, CSA		Standard single contact blocks for plug-in connector: A300; R300 Standard contact blocks for printed circuit board: B300; R300
	BV, RINA, LROS, DNV, GL (pending)		Standard single and double contact blocks with screw clamp terminals:
Terminal identification	Conforming to EN 50005 and EN 50013		

Characteristics of contact or combined contact and signalling functions			
Mechanical characteristics			
Contact operation	N/C or N/O		Slow break
Positive operation	Conforming to IEC/EN 60947-5-1 appendix K		All functions incorporating a N/C contact are positive opening operation
Operating travel (to change the electrical state)	Pushbutton	mm	Changing N/C state: 1.5 Changing N/O state: 2.6 Total travel: 4.3
		N	Changing N/C state: 3.5 Changing N/O state: 3.8
Operating force	Additional contact (extra to change state)	N	Single N/C contact: 2 Single N/O contact: 2.3
		N	Double N/C contact: 3.4 Double N/O contact: 5 Double contact N/C + N/O: 4.6
	Emergency stop with N/C + N/O	N	Standard push-pull: 45 Trigger action push-pull: 50
		N	Standard turn to release and key release: 40 Trigger action turn to release and key release: 44



### Characteristics of contact or combined contact and signalling functions (continued)

#### Mechanical characteristics (continued)

<b>Operating torque</b> (to change the electrical state)	Selector switches	<b>N.m</b>	N/O contact: 0.14
	Additional contact (extra)	<b>N.m</b>	N/O contact: 0.05
<b>Mechanical durability</b> (in millions of operating cycles)	Pushbuttons	Spring return	5
		Double-headed	1
		Push-push to release	0.5
	Selector switches	Non illuminated	3
		Illuminated	1
	Toggle switches		0.5
	Emergency stop pushbuttons		0.3
	Joystick controllers		1
	Standard contact blocks only		5
Low power switching contact blocks only (dust protected)		0.5	
<b>Vibration resistance</b>	Conforming to IEC 60068-2-6	<b>gn</b>	Frequency: 2 to 500 Hz: 5
<b>Electric shock resistance</b>	Conforming to IEC 60068-2-27	<b>gn</b>	All functions except mushroom head pushbuttons half sine wave acceleration 11 ms: 50 half sine wave acceleration 18 ms: 30
		<b>gn</b>	Mushroom head pushbutton (half sine wave acceleration 11 ms: 10)
<b>Electrical characteristics</b>			
<b>Cabling capacity</b>	Conforming to IEC 60947-1	<b>mm<sup>2</sup></b>	Screw clamp terminals Min: 1 x 0.22 without cable end Max: 2 x 1.5 with cable end Cross headed screw (Pozidrive or Philips type 1), slotted for flat 4 and 5.5 mm screwdriver Tightening torque: 0.8 N.m (max 1.2 N.m)
<b>Contact material</b>	Silver alloy (Ag / Ni)		Standard single and double blocks with screw clamp terminals Blocks for plug-in connector Standard blocks for printed circuit board connection
	Gold flashed (Ag / Ni / Au)		Low power switching contact blocks with screw clamp terminals Low power switching contact blocks for printed circuit board connection
<b>Short-circuit protection</b>	Conforming to IEC/EN 60947-5-1	<b>A</b>	Standard single and double blocks with screw clamp terminals: 10 (gG cartridge fuse conforming to IEC 60269-1) Blocks for plug-in connector: 4 (gG cartridge fuse conforming to IEC 60269-1) Standard blocks for printed circuit board connection: 4 (gG cartridge fuse conforming to IEC 60269-1)
<b>Rated thermal current</b>	Conforming to IEC/EN 60947-5-1	<b>A</b>	Standard single and double blocks with screw clamp terminals: 10 Blocks for plug-in connector: 10 Standard blocks for printed circuit board connection: 6
<b>Rated insulation voltage</b>	Conforming to IEC 60947-1	<b>V</b>	Standard single and double blocks with screw clamp terminals: U <sub>i</sub> = 600 degree of pollution 3 Blocks for plug-in connector or Faston connectors: U <sub>i</sub> = 250 degree of pollution 3 Standard blocks for printed circuit board connection: U <sub>i</sub> = 250 degree of pollution 3
<b>Rated impulse withstand voltage</b>	Conforming to IEC 60947-1	<b>kV</b>	Standard single and double blocks with screw clamp terminals: U <sub>imp</sub> = 6 Blocks for plug-in connector: U <sub>imp</sub> = 4 Standard blocks for printed circuit board connection: U <sub>imp</sub> = 4

### Characteristics of contact or combined contact and signalling functions (continued)

**Electrical characteristics** (continued)









**Rated operational characteristics**  
Conforming to IEC/EN 60947-5-1

	a.c. supply: utilisation category AC-15	Standard single and double blocks with screw clamp terminals: A600: Ue = 600 V and Ie = 1.2 A or Ue = 240 V and Ie = 3 A or Ue = 120 V and Ie = 6 A  Blocks for plug-in connector: A300: Ue = 120 V and Ie = 6 A or Ue = 240 V and Ie = 3 A  Standard blocks for printed circuit board connection: B300: Ue = 120 V and Ie = 3 A or Ue = 240 V and Ie = 1.5 A
	d.c. supply: utilisation category DC-13	Standard single and double blocks with screw clamp terminals: Q600: Ue = 600 V and Ie = 0.1 A or Ue = 250 V and Ie = 0.27 A or Ue = 125 V and Ie = 0.55 A  Joystick controllers XD5 PA/ZD5 PA : R300: Ue = 125 V and Ie = 0.22 A or Ue = 250 V and Ie = 0.1 A  Blocks for plug-in connector: R300: Ue = 125 V and Ie = 0.22 A or Ue = 250 V and Ie = 0.1 A  Standard blocks for printed circuit board connection: R300: Ue = 125 V and Ie = 0.22 A or Ue = 250 V and Ie = 0.1 A
<b>Characteristics of special contact blocks for low power switching</b>		<b>VA</b> P max: 12 <b>A</b> I max: 0.1 <b>V</b> U max: 24
<b>Electrical durability</b> Conforming to IEC/EN 60947-5-1 appendix C Operating rate 3600 operating cycles/hour. Load factor: 0.5	a.c. supply for 1 million operating cycles utilisation category AC-15	Standard single blocks with screw clamp terminals: <b>V</b> 24 120 230 <b>A</b> 4 3 2
		Standard double blocks with screw clamp terminals and blocks for plug-in connector: <b>V</b> 24 120 230 <b>A</b> 3 1.5 1
	d.c. supply for 1 million operating cycles utilisation category DC-13	Standard single blocks with screw clamp terminals: <b>V</b> 24 110 <b>A</b> 0.5 0.2
		Standard double blocks with screw clamp terminals and blocks for plug-in connector: <b>V</b> 24 110 <b>A</b> 0.4 0.15
<b>Electrical reliability</b>	Failure rate Conforming to IEC/EN 60947-5-4  - In clean environment	Standard blocks: - at 17 V and 5 mA, $\lambda < 10^{-8}$ - at 5 V and 1 mA, $\lambda < 10^{-6}$  Special blocks with gold flashed contacts, for low power switching: - at 5 V and 1 mA, $\lambda < 10^{-7}$
	- In dusty environment	Special blocks with gold flashed contacts and dust protection for low power switching only: - at 5 V and 1 mA, $\lambda < 10^{-7}$

Characteristics of signalling units (pilot lights)			
<b>Mechanical characteristics</b>			
Vibration resistance	Conforming to IEC 60068-2-6	gn	Frequency: 12 to 500 Hz: 5
Electric shock resistance	Conforming to IEC 60068-2-27	gn	Half sine wave acceleration 11 ms: 50 Half sine wave acceleration 18 ms: 30
<b>Electrical characteristics</b>			
Cabling capacity	Conforming to IEC 60947-1	mm <sup>2</sup>	Screw clamp terminals Min: 1 x 0.22 without cable end (1 x 0.34 for linking) Max: 2 x 1.5 with cable end
Rated insulation voltage	Conforming to IEC 60947-1	V	Direct supply pilot light blocks (BA 9s bulb): U <sub>i</sub> = 250 degree of pollution 3 Pilot light blocks with integral LED: U <sub>i</sub> = 250 degree of pollution 3 Pilot light blocks with transformer: U <sub>i</sub> = 600 degree of pollution 3
Rated impulse withstand voltage	Conforming to IEC 60947-1	kV	Direct supply pilot light blocks (BA 9s bulb): U <sub>imp</sub> = 4 Pilot light blocks with integral LED: U <sub>imp</sub> = 4 Pilot light blocks with transformer: U <sub>imp</sub> = 6
Specific characteristics of single light blocks with integral LED			
Voltage limits	For rated voltage	V	12 V: 10 to 15 $\overline{=}$ ; 10.2 to 13.8 $\sim$ 24 V: 19.2 to 30 $\overline{=}$ ; 21.6 to 26.4 $\sim$ 24 to 120 V: 20 to 132 $\approx$ 48 to 120 V: 40 to 132 $\sim$ 240 V: 195 to 264 $\sim$
Current consumption	Applicable to all colours	mA	Blocks with $\approx$ 12 V supply: 18 Blocks with $\approx$ 24 V supply: 18 Blocks with $\sim$ 120 V supply: 14 Blocks with $\sim$ 240 V supply: 14
Service life	At rated voltage and at an ambient temperature of 25 °C	H	100 000
Surge withstand	Conforming to IEC 61000-4-5	kV	1
Resistance to fast transients	Conforming to IEC 61000-4-4	kV	2
Resistance to electromagnetic fields	Conforming to IEC 61000-4-3	V/m	10
Resistance to electrostatic discharges	Conforming to IEC 61000-2-6	kV	8/6
Direct parallel connection across inductive load e.g.: contactor coil or solenoid	Maximum power of load	VA	For high power applications ( $\geq$ 30 VA), a <b>ZBZ V●</b> LED suppressor must be connected across the light block terminals (see page 36018/3)
Electromagnetic emission	Conforming to IEC 55011		Class B
Specific characteristics			
<b>Body/fixing collar</b>			
Tightening torque of fixing screw		N.m	0.8 (max 1.2)
<b>Hour counters and annunciators</b>			
Voltage limits	Hour counter and annunciator	V	$\pm$ 10% of the rated voltage
Current consumption	Hour counter	mA	XB5 DSB : 7 to 15 XB5 DSG : 8 XB5 DSM : 8
	Annunciator	mA	5

User assembly of other units  
using body + head sub-assemblies:  
see pages 36015/2 to 36015/6

#### Pushbuttons, spring return (screw clamp terminal connections)

Shape of head	Type of push	Type of contact		Marking	Colour of push	Reference	Weight
		N/O	N/C				
	Flush	1	-	-	Black	<b>XB5 AA21</b> (ZB5 AZ101 + ZB5 AA2)	0.037
					Green	<b>XB5 AA31</b> (ZB5 AZ101 + ZB5 AA3)	0.037
					Yellow	<b>XB5 AA51</b> (ZB5 AZ101 + ZB5 AA5)	0.037
					Blue	<b>XB5 AA61</b> (ZB5 AZ101 + ZB5 AA6)	0.037
		-	1	-	Red	<b>XB5 AA42</b> (ZB5 AZ102 + ZB5 AA4)	0.037
	Flush	1	-	"I" (white)	Green	<b>XB5 AA3311</b> (ZB5 AZ101 + ZB5 AA331)	0.037
	Flush	-	1	"O" (white)	Red	<b>XB5 AA4322</b> (ZB5 AZ102 + ZB5 AA432)	0.037
	Flush (1)	1	-	↑ (black)	White	<b>XB5 AA3341</b> (ZB5 AZ101 + ZB5 AA334)	0.037
	Flush (1)	1	-	↑ (white)	Black	<b>XB5 AA3351</b> (ZB5 AZ101 + ZB5 AA335)	0.037
	Booted (clear silicone) (colour of push unobscured)	1	-	-	Black	<b>XB5 AP21</b> (ZB5 AZ101 + ZB5 AP2)	0.039
					Green	<b>XB5 AP31</b> (ZB5 AZ101 + ZB5 AP3)	0.039
					Yellow	<b>XB5 AP51</b> (ZB5 AZ101 + ZB5 AP5)	0.039
					Blue	<b>XB5 AP61</b> (ZB5 AZ101 + ZB5 AP6)	0.039
		-	1	-	Red	<b>XB5 AP42</b> (ZB5 AZ102 + ZB5 AP4)	0.039
	Projecting	-	1	-	Red	<b>XB5 AL42</b> (ZB5 AZ102 + ZB5 AL4)	0.038
	Mushroom head Ø 40	1	-	-	Black	<b>XB5 AC21</b> (ZB5 AZ101 + ZB5 AC2)	0.062

Double-headed pushbuttons, spring return (screw clamp terminal connections)							
Shape of head	Type of push	Type of contact		Degree of protection	Reference	Weight	
		N/O	N/C				
	1 flush green push (marked "I") 1 projecting red push (marked "O")	1	1	IP 40	<b>XB5 AL845</b> (ZB5 AZ105 + ZB5 AL8434)	0.049	
				IP 66	<b>XB5 AL945</b> (ZB5 AZ105 + ZB5 AL9434)	0.054	

(1) Product supplied with cap not clipped-in, allowing orientation through 360° in 90° steps.

# Control and signalling units Ø 22





## Harmony® style 5

Pushbuttons and switches with double insulated bezel



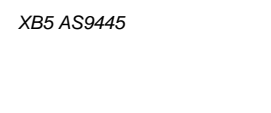

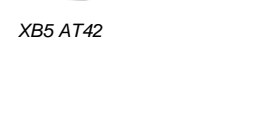

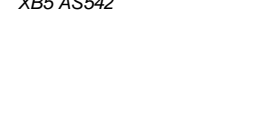







Complete units, XB5 A

User assembly of other units  
using body + head sub-assemblies:  
see pages 36015/2 to 36015/6

### Emergency stop and mushroom head pushbuttons, Ø 40 (red) (screw clamp terminal connections)

Shape of head	Type of push	Type of contact		Reference	Weight
		N/O	N/C		
	Trigger action Push-pull	1	1	<b>XB5 AT845</b> (ZB5 AZ105 + ZB5 AT84)	0.076
	Trigger action Turn to release	1	1	<b>XB5 AS8445</b> (ZB5 AZ105 + ZB5 AS844)	0.072
	Trigger action Key release (key n° 455)	1	1	<b>XB5 AS9445</b> (ZB5 AZ105 + ZB5 AS944)	0.112
	Push-pull	–	1	<b>XB5 AT42</b> (ZB5 AZ102 + ZB5 AT4)	0.065
	Turn to release	–	1	<b>XB5 AS542</b> (ZB5 AZ102 + ZB5 AS54)	0.060
	Key release (key n° 455)	–	1	<b>XB5 AS142</b> (ZB5 AZ102 + ZB5 AS14)	0.075

### Selector switches and key switches

Shape of head	Type of operator	Type of contact		Number and type of positions (1)	Reference	Weight
		N/O	N/C			
	Standard handle, black	1	–	2 - stay put 	<b>XB5 AD21</b> (ZB5 AZ101 + ZB5 AD2)	0.043
		2	–	3 - stay put 	<b>XB5 AD33</b> (ZB5 AZ103 + ZB5 AD3)	0.052
				3 - spring return to centre 	<b>XB5 AD53</b> (ZB5 AZ103 + ZB5 AD5)	0.052
	Long handle, black	1	–	2 - stay put 	<b>XB5 AJ21</b> (ZB5 AZ101 + ZB5 AJ2)	0.043
		2	–	3 - stay put 	<b>XB5 AJ33</b> (ZB5 AZ103 + ZB5 AJ3)	0.053
				3 - spring return to centre 	<b>XB5 AJ53</b> (ZB5 AZ103 + ZB5 AJ5)	0.053
	Key switch (n° 455)	1	–	2 - stay put 	<b>XB5 AG21</b> (ZB5 AZ101 + ZB5 AG2)	0.066
				2 - stay put 	<b>XB5 AG41</b> (ZB5 AZ101 + ZB5 AG4)	0.066
		2	–	2 - spring return to left 	<b>XB5 AG61</b> (ZB5 AZ101 + ZB5 AG6)	0.066
				3 - stay put 	<b>XB5 AG03</b> (ZB5 AZ103 + ZB5 AG0)	0.076
		3 - stay put 	<b>XB5 AG33</b> (ZB5 AZ103 + ZB5 AG3)	0.076		

(1) The symbol  indicates key withdrawal position(s).

User assembly of other units  
using body + head sub-assemblies:  
see pages 36016/2 and 36016/3

814288



XB5 AVB1

## Pilot lights with integral LED (screw clamp terminal connections)

Shape of head	Supply voltage V	Colour	Reference	Weight kg	
	~ 24	White	<b>XB5 AVB1</b> (ZB5 AVB1 + ZB5 AV013)	0.038	
		Green	<b>XB5 AVB3</b> (ZB5 AVB3 + ZB5 AV033)	0.038	
		Red	<b>XB5 AVB4</b> (ZB5 AVB4 + ZB5 AV043)	0.038	
		Yellow	<b>XB5 AVB5</b> (ZB5 AVB5 + ZB5 AV053)	0.038	
		Blue	<b>XB5 AVB6</b> (ZB5 AVB6 + ZB5 AV063)	0.038	
		~ 48...120	White	<b>XB5 AVG1</b> (ZB5 AVG1 + ZB5 AV013)	0.038
			Green	<b>XB5 AVG3</b> (ZB5 AVG3 + ZB5 AV033)	0.038
			Red	<b>XB5 AVG4</b> (ZB5 AVG4 + ZB5 AV043)	0.038
			Yellow	<b>XB5 AVG5</b> (ZB5 AVG5 + ZB5 AV053)	0.038
			Blue	<b>XB5 AVG6</b> (ZB5 AVG6 + ZB5 AV063)	0.038
			~ 230...240	White	<b>XB5 AVM1</b> (ZB5 AVM1 + ZB5 AV013)
		Green		<b>XB5 AVM3</b> (ZB5 AVM3 + ZB5 AV033)	0.038
	Red	<b>XB5 AVM4</b> (ZB5 AVM4 + ZB5 AV043)		0.038	
	Yellow	<b>XB5 AVM5</b> (ZB5 AVM5 + ZB5 AV053)		0.038	
	Blue	<b>XB5 AVM6</b> (ZB5 AVM6 + ZB5 AV063)		0.038	

User assembly of other units  
using body + head sub-assemblies:  
see pages 36016/2 to 36016/3

**Pilot lights for BA 9s bulb (screw clamp terminal connections)**

Shape of head	Supply voltage V	Colour	Reference	Weight kg
<b>Direct supply, for BA 9s bulb, U ≤ 250 V, 2.4 W (bulb not included)</b>				
	≤ 250	White	<b>XB5 AV61</b> (ZB5 AV6 + ZB5 AV01)	0.037
		Green	<b>XB5 AV63</b> (ZB5 AV6 + ZB5 AV03)	0.037
		Red	<b>XB5 AV64</b> (ZB5 AV6 + ZB5 AV04)	0.037
		Yellow	<b>XB5 AV65</b> (ZB5 AV6 + ZB5 AV05)	0.037

814392

XB5 AV63

**Via integral transformer with 1.2 VA, 6 V secondary. BA 9s incandescent bulb (bulb included)**



	~ 110...120 50/60 Hz	White	<b>XB5 AV31</b> (ZB5 AV3 + ZB5 AV01)	0.109
		Green	<b>XB5 AV33</b> (ZB5 AV3 + ZB5 AV03)	0.109
		Red	<b>XB5 AV34</b> (ZB5 AV3 + ZB5 AV04)	0.109
		Yellow	<b>XB5 AV35</b> (ZB5 AV3 + ZB5 AV05)	0.109
	~ 230 - 50 Hz ~ 220...240 - 60 Hz	White	<b>XB5 AV41</b> (ZB5 AV4 + ZB5 AV01)	0.110
		Green	<b>XB5 AV43</b> (ZB5 AV4 + ZB5 AV03)	0.110
		Red	<b>XB5 AV44</b> (ZB5 AV4 + ZB5 AV04)	0.110
		Yellow	<b>XB5 AV45</b> (ZB5 AV4 + ZB5 AV05)	0.110

814391

XB5 AV34

User assembly of other units using body + head sub-assemblies: see pages 36017/2 to 36017/7



#### Illuminated pushbuttons, spring return, flush push

Shape of head	Description	Type of contact		Supply voltage	Colour of push	Reference	Weight	
		N/O	N/C					
<b>Screw clamp terminal connections</b>								
 XB5 AW31B5	Integral LED <b>Protected LED</b>	1	1	≈ 24	White	<b>XB5 AW31B5</b> (ZB5 AW0B15 + ZB5 AW313)	0.056	
					Green	<b>XB5 AW33B5</b> (ZB5 AW0B35 + ZB5 AW333)	0.056	
					Red	<b>XB5 AW34B5</b> (ZB5 AW0B45 + ZB5 AW343)	0.056	
					Yellow	<b>XB5 AW35B5</b> (ZB5 AW0B55 + ZB5 AW353)	0.056	
					Blue	<b>XB5 AW36B5</b> (ZB5 AW0B65 + ZB5 AW363)	0.056	
					~ 48...120	White	<b>XB5 AW31G5</b> (ZB5 AW0G15 + ZB5 AW313)	0.056
					Green	<b>XB5 AW33G5</b> (ZB5 AW0G35 + ZB5 AW333)	0.056	
					Red	<b>XB5 AW34G5</b> (ZB5 AW0G45 + ZB5 AW343)	0.056	
					Yellow	<b>XB5 AW35G5</b> (ZB5 AW0G55 + ZB5 AW353)	0.056	
					Blue	<b>XB5 AW36G5</b> (ZB5 AW0G65 + ZB5 AW363)	0.056	
					~ 230...240	White	<b>XB5 AW31M5</b> (ZB5 AW0M15 + ZB5 AW313)	0.056
					Green	<b>XB5 AW33M5</b> (ZB5 AW0M35 + ZB5 AW333)	0.056	
					Red	<b>XB5 AW34M5</b> (ZB5 AW0M45 + ZB5 AW343)	0.056	
					Yellow	<b>XB5 AW35M5</b> (ZB5 AW0M55 + ZB5 AW353)	0.056	
					Blue	<b>XB5 AW36M5</b> (ZB5 AW0M65 + ZB5 AW363)	0.056	
					 XB5 AW3465	Direct supply for BA 9s bulb, 2.4 W max. (not included)	1	1
Green	<b>XB5 AW3365</b> (ZB5 AW065 + ZB5 AW33)	0.057						
Red	<b>XB5 AW3465</b> (ZB5 AW065 + ZB5 AW34)	0.057						
Yellow	<b>XB5 AW3565</b> (ZB5 AW065 + ZB5 AW35)	0.057						





User assembly of other units  
using body + head sub-assemblies:  
see pages 36017/2 to 36017/9

## Illuminated pushbuttons, spring return, flush push (continued)



Shape of head	Description	Type of contact		Supply voltage	Colour of push	Reference	Weight
				V			kg
<b>Screw clamp terminal connections</b>							
 563461 XB5 AW3335	Via integral transformer 6 V secondary, BA 9s incandescent bulb (included)	1	1	~ 110...120 50/60 Hz	White	<b>XB5 AW3135</b> (ZB5 AW035 + ZB5 AW31)	0.128
					Green	<b>XB5 AW3335</b> (ZB5 AW035 + ZB5 AW33)	0.128
					Red	<b>XB5 AW3435</b> (ZB5 AW035 + ZB5 AW34)	0.128
					Yellow	<b>XB5 AW3535</b> (ZB5 AW035 + ZB5 AW35)	0.128
					White	<b>XB5 AW3145</b> (ZB5 AW045 + ZB5 AW31)	0.129
					Green	<b>XB5 AW3345</b> (ZB5 AW045 + ZB5 AW33)	0.129
					Red	<b>XB5 AW3445</b> (ZB5 AW045 + ZB5 AW34)	0.129
					Yellow	<b>XB5 AW3545</b> (ZB5 AW045 + ZB5 AW35)	0.129
					White	<b>XB5 AW3145</b> (ZB5 AW045 + ZB5 AW31)	0.129
					Green	<b>XB5 AW3345</b> (ZB5 AW045 + ZB5 AW33)	0.129

## Double-headed pushbuttons, spring return, with integral LED pilot light (IP 40) (1)

## Screw clamp terminal connections



Shape of head	Description	Type of contact		Supply voltage	Colour of push	Reference	Weight
				V			kg
<b>Screw clamp terminal connections</b>							
 814405 XB5 AW84B5	1 flush green push (marked "I") 1 yellow pilot light 1 red projecting push (marked "O") <b>Protected LED</b>	1	1	~ 24	–	<b>XB5 AW84B5</b> (ZB5 AW0B55 + ZB5 AW843743)	0.060
					–	<b>XB5 AW84G5</b> (ZB5 AW0G55 + ZB5 AW843743)	0.060
					–	<b>XB5 AW84M5</b> (ZB5 AW0M55 + ZB5 AW843743)	0.060

## Illuminated selector switches with integral LED (2-position stay put) ✓

Shape of head	Type of operator	Type of contact		Supply voltage	Colour of handle	Reference	Weight
				V			kg
<b>Screw clamp terminal connections</b>							
 814406 XB5 AK124B5	Standard handle <b>Protected LED</b>	1	1	~ 24	Green	<b>XB5 AK123B5</b> (ZB5 AW0B35 + ZB5 AK1233)	0.059
					Red	<b>XB5 AK124B5</b> (ZB5 AW0B45 + ZB5 AK1243)	0.059
					Yellow	<b>XB5 AK125B5</b> (ZB5 AW0B55 + ZB5 AK1253)	0.059
					Green	<b>XB5 AK123G5</b> (ZB5 AW0G35 + ZB5 AK1233)	0.059
					Red	<b>XB5 AK124G5</b> (ZB5 AW0G45 + ZB5 AK1243)	0.059
					Yellow	<b>XB5 AK125G5</b> (ZB5 AW0G55 + ZB5 AK1253)	0.059
					Green	<b>XB5 AK123M5</b> (ZB5 AW0M35 + ZB5 AK1233)	0.059
					Red	<b>XB5 AK124M5</b> (ZB5 AW0M45 + ZB5 AK1243)	0.059
					Yellow	<b>XB5 AK125M5</b> (ZB5 AW0M55 + ZB5 AK1253)	0.059

(1) For IP 66 degree of protection, fit a clear sealing boot: **ZBW 008** or **ZBW 008A**. See page 36018/15.

To combine with heads:  
see pages 36015/3 to 36015/9











Complete bodies (fixing collar + single contact block)				
Description	Type of contact		Reference	Weight kg
	N/O	N/C		
 <p>ZB5 AZ101</p>	1	–	ZB5 AZ101	0.021
	–	1	ZB5 AZ102	0.021
	2	–	ZB5 AZ103	0.030
	–	2	ZB5 AZ104	0.030
	1	1	ZB5 AZ105	0.030
	1	2	ZB5 AZ141	0.040
 <p>ZB5 AZ102</p>	1	–	ZB5 AZ1014	0.018
	–	1	ZB5 AZ1024	0.018
	2	–	ZB5 AZ1034	0.026
	–	2	ZB5 AZ1044	0.026
	1	1	ZB5 AZ1054	0.026
	1	2	ZB5 AZ1414	0.036

Contact blocks	
Description	
Separate contact blocks	See page 36018/12

(1) Connecting cables and connector for plug-in connector contact blocks: see page 36018/4.

**Other versions** Complete bodies with Faston connector terminals (6.35 or 2 x 2.8).  
Please consult your Regional Sales Office.

To combine with bodies:  
see page 36015/2

Heads for spring return pushbuttons - unmarked					
Shape of head	Type of push	Colour of cap	Reference	Weight kg	
 814416  ZB5 AA0	Without cap (1) Flush, with set of 6 coloured caps	–	ZB5 AA0	0.022	
		6 colours (2)	ZB5 AA9	0.027	
 814417  ZB5 AA5	Flush	White	ZB5 AA1	0.018	
		Black	ZB5 AA2	0.018	
		Green	ZB5 AA3	0.018	
		Red	ZB5 AA4	0.018	
		Yellow	ZB5 AA5	0.018	
		Blue	ZB5 AA6	0.018	
 814418  ZB5 AL3	Flush with transparent cap, for insertion of legend (3)	White	ZB5 AA8	0.018	
		Green	ZB5 AA18	0.018	
		Red	ZB5 AA38	0.018	
		Yellow	ZB5 AA48	0.018	
		Blue	ZB5 AA58	0.018	
		Blue	ZB5 AA68	0.018	
 814419  ZB5 AP1	Projecting	White	ZB5 AL1	0.019	
		Black	ZB5 AL2	0.019	
		Green	ZB5 AL3	0.019	
		Red	ZB5 AL4	0.019	
		Yellow	ZB5 AL5	0.019	
		Blue	ZB5 AL6	0.019	
 814419  ZB5 AP2S	Booted (clear silicone) Colour of push unobscured	White	ZB5 AP1	0.021	
		Black	ZB5 AP2	0.021	
		Green	ZB5 AP3	0.021	
		Red	ZB5 AP4	0.021	
		Yellow	ZB5 AP5	0.021	
		Blue	ZB5 AP6	0.021	
 103545_1  ZB5 AP18	Booted (coloured silicone) Can be replaced without dismantling the head. Compatible with legend holder	White	ZB5 AP1S	0.014	
		Black	ZB5 AP2S	0.014	
		Green	ZB5 AP3S	0.014	
		Red	ZB5 AP4S	0.014	
		Yellow	ZB5 AP5S	0.014	
		Blue	ZB5 AP6S	0.014	
 814420  ZB5 CA2	Booted (clear silicone), for insertion of legend (3) (colour of push unobscured)	White	ZB5 AP18	0.023	
		Green	ZB5 AP38	0.023	
		Red	ZB5 AP48	0.023	
		Yellow	ZB5 AP58	0.023	
		Blue	ZB5 AP68	0.023	
		Blue	ZB5 AP68	0.023	
 814421  ZB5 CA5	Flush (high bezel)	White	ZB5 AA14	0.020	
		Black	ZB5 AA24	0.020	
		Green	ZB5 AA34	0.020	
		Red	ZB5 AA44	0.020	
		Yellow	ZB5 AA54	0.020	
		Blue	ZB5 AA64	0.020	
 814421  ZB5 CL1	Recessed (high guard)	White	ZB5 AA16	0.020	
		Black	ZB5 AA26	0.020	
		Green	ZB5 AA36	0.020	
		Red	ZB5 AA46	0.020	
		Yellow	ZB5 AA56	0.020	
		Blue	ZB5 AA66	0.020	
 814421  ZB5 CA0	Without cap (1) Flush	–	ZB5 CA0	0.022	
		White	ZB5 CA1	0.019	
		Black	ZB5 CA2	0.019	
		Green	ZB5 CA3	0.019	
		Red	ZB5 CA4	0.019	
		Yellow	ZB5 CA5	0.019	
 814421  ZB5 CL6	Projecting	Blue	ZB5 CA6	0.019	
		White	ZB5 CL1	0.021	
		Black	ZB5 CL2	0.021	
		Green	ZB5 CL3	0.021	
		Red	ZB5 CL4	0.021	
		Yellow	ZB5 CL5	0.021	
	Blue	ZB5 CL6	0.021		

(1) Cap to be ordered separately, see page 36018/6.

(2) Head supplied with 6 different coloured caps (white, black, green red, yellow, blue).

(3) For legend ordering information, see page 36018/12.

To combine with bodies:  
see page 36015/2



ZB5 AA331



ZB5 AA432



ZB5 AL232

## Heads for spring return pushbuttons - marked

Shape of head	Type of push	Marking		Colour of cap	Reference	Weight kg			
		Text	Colour						
	Flush (1)	I	White	Green	ZB5 AA331	0.018			
			Black	White	ZB5 AA131	0.018			
		II	White	Green	ZB5 AA336	0.018			
			Black	White	ZB5 AA136	0.018			
		START	White	Green	ZB5 AA333	0.018			
			Black	White	ZB5 AA133	0.018			
		ON	White	Green	ZB5 AA341	0.018			
			Black	White	ZB5 AA141	0.018			
		MARCHE	White	Green	ZB5 AA342	0.018			
			Black	White	ZB5 AA142	0.018			
				White	Black	ZB5 AA245	0.018		
				Black	White	ZB5 AA145	0.018		
		O	White	Red	Black	ZB5 AA432	0.018		
				Black	Black	ZB5 AA232	0.018		
		ARRET	White	Red	Black	ZB5 AA433	0.018		
				Black	Black	ZB5 AA233	0.018		
		STOP	White	Red	Black	ZB5 AA434	0.018		
				Black	Black	ZB5 AA234	0.018		
		OFF	White	Red	Black	ZB5 AA435	0.018		
				Black	Black	ZB5 AA235	0.018		
UP	Black	White	Black	ZB5 AA343	0.018				
		Black	Black	ZB5 AA344	0.018				
DOWN	White	Black	Black	ZB5 AA335	0.018				
		Black	White	ZB5 AA334	0.018				
	Projecting (1)	O	White	Red	ZB5 AL432	0.019			
			Black	Black	ZB5 AL232	0.019			
		ARRET	White	Red	Black	ZB5 AL433	0.019		
				Black	Black	ZB5 AL233	0.019		
		STOP	White	Red	Black	ZB5 AL434	0.019		
				Black	Black	ZB5 AL234	0.019		
		OFF	White	Red	Black	ZB5 AL435	0.019		
				Black	Black	ZB5 AL235	0.019		
			Flush (1)	I	White	Green	ZB5 CA331	0.019	
					Black	White	ZB5 CA432	0.019	
				+	White	Black	Black	ZB5 CA2934	0.019
						Black	Black	ZB5 CA2912	0.019
				R	White	Black	Blue	ZB5 CA6939	0.019
		Black	Blue			ZB5 CA6939	0.019		

## Heads for lockable "push-turn" pushbuttons

Shape of head	Key type	Locking	Key withdrawal	Reference	Weight kg
	Key n° 4A185	Both positions	Both positions	ZB5 AFDA	0.050
		Actuated position	Actuated position	ZB5 AFDB	0.050
		Rest position	Rest position	ZB5 AFDC	0.050
		Actuated position	Both positions	ZB5 AFDD	0.050
	Key LU1	Both positions	Both positions	ZB5 AFDE01	0.050
	Key LU2	Both positions	Both positions	ZB5 AFDE02	0.050
	Key LU3	Both positions	Both positions	ZB5 AFDE03	0.050
	Key LU4	Both positions	Both positions	ZB5 AFDE04	0.050
	Key LU5	Both positions	Both positions	ZB5 AFDE05	0.050
	Key LU6	Both positions	Both positions	ZB5 AFDE06	0.050
	Key LU7	Both positions	Both positions	ZB5 AFDE07	0.050
	Key LU8	Both positions	Both positions	ZB5 AFDE08	0.050
	Key LU9	Both positions	Both positions	ZB5 AFDE09	0.050
	Key LU10	Both positions	Both positions	ZB5 AFDE10	0.050
	Key LU11	Both positions	Both positions	ZB5 AFDE11	0.050
	Key LU12	Both positions	Both positions	ZB5 AFDE12	0.050
Key LU13	Both positions	Both positions	ZB5 AFDE13	0.050	
Key LU14	Both positions	Both positions	ZB5 AFDE14	0.050	
Key LU15	Both positions	Both positions	ZB5 AFDE15	0.050	



(1) Push supplied with cap not clipped-in, allowing orientation through 360° in 90° steps.

To combine with bodies:  
see page 36015/2



## Heads for "push-turn" pushbuttons with knurled knob

Shape of head	Description	Marking	Reference	Weight kg
	Knurled knob without cap	–	ZB5 AF	0.027
	Knurled knob with marked cap	↑ (white on black background)	ZB5 AF351	0.030

## Heads for double-headed, spring return pushbuttons

Shape of head	Description	Colour of pushes	Degree of protection	Reference	Weight kg
<b>Without function marking on pushes</b>					
	2 flush pushes	Green	IP 40 (1)	ZB5 AA8134	0.022
		Red	IP 66	ZB5 AA9134	0.027
		White	IP 40 (1)	ZB5 AA8112	0.022
		Black	IP 66	ZB5 AA9112	0.027
	1 flush push 1 projecting push	Green	IP 40 (1)	ZB5 AL8334	0.021
		Red	IP 66	ZB5 AL9334	0.026
		White	IP 40 (1)	ZB5 AL8312	0.021
		Black	IP 66	ZB5 AL9312	0.026

## With function marking on pushes

	2 flush pushes (marked "I") (marked "O")	Green	IP 40 (1)	ZB5 AA8234	0.022
		Red	IP 66	ZB5 AA9234	0.027
		White	IP 40 (1)	ZB5 AA8212	0.022
		Black	IP 66	ZB5 AA9212	0.027
	1 flush push 1 projecting push	Green	IP 40 (1)	ZB5 AL8434	0.021
		Red	IP 66	ZB5 AL9434	0.026
		White	IP 40 (1)	ZB5 AL8412	0.021
		Black	IP 66	ZB5 AL9412	0.026

## Heads for "push-push to release" pushbuttons (2)

Shape of head	Type of push	Colour of push	Reference	Weight kg
	Without cap (3)	–	ZB5 AH0	0,018
	Flush	White	ZB5 AH01	0,018
		Black	ZB5 AH02	0,018
		Green	ZB5 AH03	0,018
		Red	ZB5 AH04	0,018
		Yellow	ZB5 AH05	0,018
		Blue	ZB5 AH06	0,018
	Projecting	White	ZB5 AH1	0,018
		Black	ZB5 AH2	0,018
		Green	ZB5 AH3	0,018
		Red	ZB5 AH4	0,018
		Yellow	ZB5 AH5	0,018
		Blue	ZB5 AH6	0,018
	Without cap (3)	–	ZB5 CH0	0,020
	Flush	White	ZB5 CH01	0,020
		Black	ZB5 CH02	0,020
		Green	ZB5 CH03	0,020
		Red	ZB5 CH04	0,020
		Yellow	ZB5 CH05	0,020
		Blue	ZB5 CH06	0,020

(1) NEMA type 1.

(2) Maximum of 1 row of 3 contact blocks on associated body/fixing collar sub-assembly.

(3) Coloured cap to be ordered separately: see page 36018/6.



ZB5 AL8334



ZB5 AL9334



ZB5 AL8434



ZB5 AH04

To combine with bodies:  
see page 36015/2

### Mushroom heads for spring return pushbuttons



ZB5 AC24



Shape of head	Diameter of push mm	Colour of push	Reference	Weight kg
Circular	30	Black	ZB5 AC24	0.027
		Green	ZB5 AC34	0.027
		Red	ZB5 AC44	0.027
		Yellow	ZB5 AC54	0.027
		Blue	ZB5 AC64	0.027
Circular	40	Black	ZB5 AC2	0.046
		Green	ZB5 AC3	0.046
		Red	ZB5 AC4	0.046
		Yellow	ZB5 AC5	0.046
		Blue	ZB5 AC6	0.046
Circular	60	Black	ZB5 AR2	0.065
		Green	ZB5 AR3	0.065
		Red	ZB5 AR4	0.065
		Yellow	ZB5 AR5	0.065
		Blue	ZB5 AR6	0.065
Hemispherical	60	Black	ZB5 AR216	0.048
		Green	ZB5 AR316	0.048
		Red	ZB5 AR416	0.048
		Yellow	ZB5 AR516	0.048
		Blue	ZB5 AR616	0.048



ZB5 AC2



ZB5 AR4















ZB5 AR216

To combine with bodies:  
see page 36015/2

## Mushroom heads for latching pushbuttons

(Emergency stop: colour red)

Shape of head	Type of push	Diameter of push mm	Colour of push	Reference	Weight kg
 ZB5 AS844		40	Red	ZB5 AT84	0.050
		30	Red	ZB5 AS834	0.042
40		Red	ZB5 AS844	0.046	
 ZB5 AS934		30	Red	ZB5 AS934	0.068
		40	Red	ZB5 AS944 (2)	0.071
		60	Red	ZB5 AS934	0.092
		40	Red	ZB5 AS944D	0.071
 ZB5 AT4		30	Black	ZB5 AT24	0.044
		40	Black	ZB5 AT2	0.049
			Red	ZB5 AT4	0.049
		60	Black	ZB5 AX2	0.067
			Red	ZB5 AX4	0.067
		30	Black	ZB5 AS42	0.040
			Red	ZB5 AS44	0.040
		40	Black	ZB5 AS52	0.044
			Red	ZB5 AS54	0.044
			Yellow	ZB5 AS55	0.044
 ZB5 AS64		60	Black	ZB5 AS62	0.064
			Red	ZB5 AS64	0.064
		30	Black	ZB5 AS72	0.040
			Red	ZB5 AS74	0.040
		40	Black	ZB5 AS12	0.044
			Red	ZB5 AS14 (2)	0.044
		60	Black	ZB5 AS22	0.064
			Red	ZB5 AS24	0.064
	Key release (key n° 4A185)	40	Red	ZB5 AS14D	0.044

(1) Maximum number of contacts fitted to the associated body: 4.

Example : 4 single contact blocks, 2 double contact blocks, or 2 single contact blocks + 1 double contact block. See page 36018/2

(2) Other key numbers:

- key n° 421E: add suffix **12** to the reference.

- key n° 458A: add suffix **10** to the reference.

- key n° 520E: add suffix **14** to the reference.

- key n° 3131A: add suffix **20** to the reference.

Example : For a Ø 40 mushroom head for a trigger action, latching pushbutton, with release by key n° 421E, the reference becomes: **ZB5 AS94412**.

(3) For specific keys with other numbers, please consult your Regional Sales Office.

## Control and signalling units Ø 22

## Harmony® style 5

Pushbuttons and switches with double insulated bezel

Sub-assemblies ZB5 A : heads

To combine with bodies:  
see page 36015/2

814483



ZB5 AD●

## Heads for selector switches (1)





























Shape of head	Type of operator	Number and type of positions		Reference	Weight kg
	Standard handle, black	2 - stay put		ZB5 AD2	0.024
		2 - stay put with actuation of the centre contact		ZB5 AD2M	0.024
		2 - spring return from right to left		ZB5 AD4	0.024
		2 - spring return from right to left with actuation of centre contact		ZB5 AD4M	0.024
		3 - stay put		ZB5 AD3	0.024
		3 - spring return to centre		ZB5 AD5	0.024
		3 - spring return from left to centre		ZB5 AD7	0.024
		3 - spring return from right to centre		ZB5 AD8	0.024
		Standard handle, white	2 - stay put		ZB5 AD201
	2 - spring return from right to left			ZB5 AD401	0.024
	3 - stay put			ZB5 AD301	0.024
	3 - spring return to centre			ZB5 AD501	0.024
	3 - spring return from left to centre			ZB5 AD701	0.024
3 - spring return from right to centre			ZB5 AD801	0.024	
Standard handle, green	2 - stay put		ZB5 AD203	0.024	
	2 - spring return from right to left		ZB5 AD403	0.024	
	3 stay put		ZB5 AD303	0.024	
	3 - spring return to centre		ZB5 AD503	0.024	
	3 - spring return from left to centre		ZB5 AD703	0.024	
		3 - spring return from right to centre		ZB5 AD803	0.024

(1) Can only be used for actuation of end row (side) mounted contacts.



To combine with bodies:  
see page 36015/2

## Heads for selector switches (1) (continued)

Shape of head	Type of operator	Number and type of positions		Reference	Weight kg
 ZB5 AD●●	Standard handle, red	2 - stay put		ZB5 AD204	0.024
		2 - spring return from right to left		ZB5 AD404	0.024
		3 stay put		ZB5 AD304	0.024
		3 - spring return to centre		ZB5 AD504	0.024
		3 - spring return from left to centre		ZB5 AD704	0.024
		3 - spring return from right to centre		ZB5 AD804	0.024
	Standard handle, yellow	2 - stay put		ZB5 AD205	0.024
		2 - spring return from right to left		ZB5 AD405	0.024
		3 stay put		ZB5 AD305	0.024
		3 - spring return to centre		ZB5 AD505	0.024
		3 - spring return from left to centre		ZB5 AD705	0.024
		3 - spring return from right to centre		ZB5 AD805	0.024
	Standard handle, blue	2 - stay put		ZB5 AD206	0.024
		2 - spring return from right to left		ZB5 AD406	0.024
		3 stay put		ZB5 AD306	0.024
		3 - spring return to centre		ZB5 AD506	0.024
		3 - spring return from left to centre		ZB5 AD706	0.024
		3 - spring return from right to centre		ZB5 AD806	0.024
 ZB5 AJ3	Long handle, black	2 - stay put		ZB5 AJ2	0.025
		2 - stay put with actuation of the centre contact		ZB5 AJ2M	0.025
		2 - spring return from right to left		ZB5 AJ4	0.025
		2 - spring return from right to left with actuation of centre contact		ZB5 AJ4M	0.025
		3 - stay put		ZB5 AJ3	0.025
		3 - spring return to centre		ZB5 AJ5	0.025
		3 - spring return from left to centre		ZB5 AJ7	0.025
		3 - spring return from right to centre		ZB5 AJ8	0.025

(1) Can only be used for actuation of end row (side) mounted contacts.

To combine with bodies:  
see page 36015/2

## Heads for selector switches (1) (continued)



ZB5 AD●●



Shape of head	Type of operator	Number and type of positions (2)	Reference	Weight kg
	Knurled knob, black	2 - stay put	ZB5 AD29	0.027
		2 - spring return from right to left	ZB5 AD49	0.027
		3 - stay put	ZB5 AD39	0.027
		3 - spring return to centre	ZB5 AD59	0.027
		3 - spring return from left to centre	ZB5 AD79	0.027
		3 - spring return from right to centre	ZB5 AD89	0.027



ZB5 AG●



Shape of head	Type of operator	Number and type of positions (2)	Reference	Weight kg
	Key switch (key n° 455) (4)	2 - stay put	ZB5 AG2 (3)	0.050
			ZB5 AG4 (3)	0.050
		2 - stay put with actuation of the centre contact	ZB5 AG2M	0.050
			ZB5 AG4M	0.050
		2 - spring return from right to left	ZB5 AG6 (3)	0.050
		2 - spring return from right to left with actuation of centre contact	ZB5 AG6M	0.050
		3 - stay put	ZB5 AG0 (3)	0.050
			ZB5 AG3 (3)	0.050
			ZB5 AG5 (3)	0.050
			ZB5 AG9 (3)	0.050
			ZB5 AG09 (3)	0.050
		3 - spring return from left to centre	ZB5 AG1 (3)	0.050
		2 - spring return to centre	ZB5 AG7 (3)	0.050
		3 - spring return from right to centre	ZB5 AG8 (3)	0.050
			ZB5 AG08 (3)	0.050

(1) Can only be used for actuation of end row (side) mounted contacts.

(2) The symbol indicates key withdrawal position(s).

(3) Other key numbers:

- key n° 421E: add suffix **12** to the reference,
- key n° 458A: add suffix **10** to the reference,
- key n° 520E: add suffix **14** to the reference,
- key n° 3131A: add suffix **20** to the reference.

Example :

For a switch head with key n° 421E, 2-position stay put with key withdrawal from the left-hand position, the reference becomes : **ZB5 AG212**.

(4) For specific keys with other numbers, please consult your Regional Sales Office.

To combine with bodies:  
see page 36015/2

**CONG TY CO PHAN THIET BI DIEN LONG NGUYEN**  
**www.evnonline.vn – Tell 04 354 09147 – Mobile 0912290680**



ZB5 AG●●

## Heads for selector switches (1) (continued)

Shape of head	Type of operator	Number and type of positions (2)		Reference	Weight kg				
	Key switch (key n° 8D1)	2 - stay put		ZB5 AG2D	0.050				
				ZB5 AG02D	0.050				
				ZB5 AG4D	0.050				
		2 - spring return from right to left			ZB5 AG6D	0.050			
					ZB5 AG0D	0.050			
					ZB5 AG3D	0.050			
		3 - stay put			ZB5 AG5D	0.050			
					ZB5 AG9D	0.050			
					ZB5 AG09D	0.050			
					ZB5 AG03D	0.050			
					ZB5 AG04D	0.050			
					3 - spring return from left to centre			ZB5 AG06D	0.050
								ZB5 AG1D	0.050
								ZB5 AG07D	0.050
					3 - spring return from right to centre			ZB5 AG8D	0.050
			ZB5 AG08D	0.050					
			ZB5 AG05D	0.050					
		2 - spring return to centre			ZB5 AG7D	0.050			

## Heads for toggle switches

Shape of head	Description	Lever	Type of position	Reference	Weight kg	
	2-position	Black	Stay put	ZB5 AD28	0.023	
			Spring return	ZB5 AD48	0.023	
		White	Stay put	ZB5 AD2801	0.023	
				Red	ZB5 AD2804	0.023
					Blue	ZB5 AD2806

(1) Can only be used for actuation of end row (side) mounted contacts.

(2) The symbol indicates key withdrawal position(s).







ZB5 AD28

563091



XB5 AA

**Manual overload reset buttons (travel 10 mm) (1)**

Shape of head	Actuation distance mm	Marking	Colour	Reference	Weight kg	
<b>Without cap (2)</b>						
	17...120	–	–	<b>XB5 AA801</b>	0.027	
	120...257	–	–	<b>XB5 AA802</b>	0.040	
<b>With flush push</b>						
	17...120	Without	Green	<b>XB5 AA831</b>	0.027	
			Red	<b>XB5 AA841</b>	0.027	
			Blue	<b>XB5 AA861</b>	0.027	
	120...257	Without	O	Red	<b>XB5 AA84101</b>	0.027
			R	Blue	<b>XB5 AA86102</b>	0.027
			Green	<b>XB5 AA832</b>	0.040	
	120...257	Without	Red	<b>XB5 AA842</b>	0.040	
			Blue	<b>XB5 AA862</b>	0.040	
			O	Red	<b>XB5 AA84201</b>	0.040
			R	Blue	<b>XB5 AA86202</b>	0.040
<b>With projecting push</b>						
	17...120	O	Red	<b>XB5 AL84101</b>	0.027	
	120...257	O	Red	<b>XB5 AL84201</b>	0.040	
<b>Heads + mounting base for potentiometer</b>						
Shape of head	Description	For use on	Reference	Weight kg		
	For potentiometer with shaft length 44 to 50 mm (potentiometer not included)	Ø 6 mm shaft	<b>ZB5 AD912</b>	0.032		
		Ø 6.35 mm shaft	<b>ZB5 AD922</b>	0.032		

(1) NEMA type 13.

(2) Coloured cap to be ordered separately: see page 36018/6.

**CONG TY CO PHAN THIET BI ĐIỆN LONG NGUYEN**  
[www.evnonline.vn](http://www.evnonline.vn) – Tell 04 354 09147 – Mobile 0912290680

**Joystick controllers** (54 mm long operating shaft) (1)**Complete joystick controllers** (screw clamp terminal connections)

Description	Operation	Spring return to zero position	Reference	Weight kg
2 direction	1 notch 1 N/O contact per direction	Without	<b>XD5 PA12</b>	0.060
		With	<b>XD5 PA22</b>	0.060
4 direction	1 notch 1 N/O contact per direction	Without	<b>XD5 PA14</b>	0.077
		With	<b>XD5 PA24</b>	0.077



XD5 PA12



ZD5 PA103



ZD5 PA203



ZD5 PA12

**Sub-assemblies for joystick controllers**

Description	For use on	Reference	Weight kg	
<b>Complete body/contact assemblies</b> (screw clamp terminal connections)	2 direction	<b>ZD5 PA103</b>	0.049	
	4 direction	<b>ZD5 PA203</b>	0.058	
<b>Complete head assemblies with operating shaft</b>	2 direction, stay put	<b>ZD5 PA12</b>	0.022	
	2 direction, spring return to zero position	<b>ZD5 PA22</b>	0.022	
	4 direction, stay put	<b>ZD5 PA14</b>	0.022	
	4 direction, spring return to zero position	<b>ZD5 PA24</b>	0.022	
<b>Legends 30 x 48 mm for engraving</b>	2 direction	Black one side Red reverse	<b>ZBG 2201</b>	0.001
		White one side Yellow reverse	<b>ZBG 2401</b>	0.001
		Black one side Red reverse	<b>ZBG 4201</b>	0.002
<b>Legends 48 x 48 mm for engraving</b>	4 direction	White one side Yellow reverse	<b>ZBG 4401</b>	0.002

**Hour counters** (2)

Characteristics	Supply voltage V	Reference	Weight kg
<b>Indication 0...9999.9</b>	≈ 12...24 - 50/60 Hz	<b>XB5 DSB</b>	0.045
	~ 120 - 60 Hz	<b>XB5 DSG</b>	0.045
	~ 230...240 - 50 Hz	<b>XB5 DSM</b>	0.045



XB5 DS

**Annunciators** (IP 40 NEMA 1) (2)

Characteristics	Supply voltage V	Reference	Weight kg
<b>85 db buzzer, basic: 4 kHz</b> with continuous or intermittent operation (connection diagram: see page 36021/8)	≈ 24 - 50/60 Hz	<b>XB5 KSB</b>	0.035
	~ 120 - 50/60 Hz	<b>XB5 KSG</b>	0.035
	~ 230...240 - 50 Hz	<b>XB5 KSM</b>	0.035



XB5 KS

**Fuse carrier** (2)

Description	For use with	Reference	Weight kg
<b>Fuse carrier</b>	5 x 20 mm fuse 6.3 A - 250 V	<b>XB5 DT1S</b>	0.022



XB5 DT1S

(1) Cannot be used with standard contact blocks ZBE 101 (single) or ZBE 20 (double).

(2) Replacement parts: fixing nut ZB5 AZ901, anti-rotation plate: ZB5 AZ902, tightening key: ZB5 AZ905.

**Other versions**

Joystick controllers and complete body/contact assemblies for joystick controllers with Faston connector terminals (6.35 or 2 x 2.8). Please consult your Regional Sales Office.



# Control and signalling units Ø 22

Harmony® style 5

Illuminated pushbuttons and switches with double insulated bezel

Sub-assemblies ZB5 A : bodies

To combine with heads for integral LED:  
see pages 36017/7 to 36017/9

Complete bodies (fixing collar + single contact block + light block with integral LED)						
Light source	Supply voltage	Type of contact (1)		Colour of light source	Reference	Weight
						
	V	N/O	N/C			kg
<b>Screw clamp terminal connections</b>						
Integral LED 	~ 24	1	-	White	ZB5 AW0B11	0.032
				Green	ZB5 AW0B31	0.032
				Red	ZB5 AW0B41	0.032
				Yellow	ZB5 AW0B51	0.032
				Blue	ZB5 AW0B61	0.032
		-	1	White	ZB5 AW0B12	0.032
				Green	ZB5 AW0B32	0.032
				Red	ZB5 AW0B42	0.032
				Yellow	ZB5 AW0B52	0.032
				Blue	ZB5 AW0B62	0.032
2	-	White	ZB5 AW0B13	0.042		
		Green	ZB5 AW0B33	0.042		
		Red	ZB5 AW0B43	0.042		
		Yellow	ZB5 AW0B53	0.042		
		Blue	ZB5 AW0B63	0.042		
1	1	White	ZB5 AW0B15	0.042		
		Green	ZB5 AW0B35	0.042		
		Red	ZB5 AW0B45	0.042		
		Yellow	ZB5 AW0B55	0.042		
		Blue	ZB5 AW0B65	0.042		
~ 48...120	1	-	White	ZB5 AW0G11	0.032	
			Green	ZB5 AW0G31	0.032	
			Red	ZB5 AW0G41	0.032	
			Yellow	ZB5 AW0G51	0.032	
			Blue	ZB5 AW0G61	0.032	
	-	1	White	ZB5 AW0G12	0.032	
			Green	ZB5 AW0G32	0.032	
			Red	ZB5 AW0G42	0.032	
			Yellow	ZB5 AW0G52	0.032	
			Blue	ZB5 AW0G62	0.032	

(1) Can be fitted with additional contact blocks: see page 36018/2.

**Other versions**

Complete bodies with Faston connector terminals (6.35 or 2 x 2.8).  
Please consult your Regional Sales Office.

814532





ZB5 AW0001

814533



ZB5 AW0003

To combine with heads for integral LED:  
see pages 36017/7 to 36017/9

Complete bodies (fixing collar + single contact block + light block with integral LED)							
Light source	Supply voltage	Type of contact (1)		Colour of light source	Reference	Weight	
							
	V	N/O	N/C			kg	
<b>Screw clamp terminal connections (continued)</b>							
Integral LED 	~ 48...120	2	-	White	ZB5 AW0G13	0.042	
				Green	ZB5 AW0G33	0.042	
				Red	ZB5 AW0G43	0.042	
				Yellow	ZB5 AW0G53	0.042	
				Blue	ZB5 AW0G63	0.042	
	~ 230...240	1	1	White	ZB5 AW0G15	0.042	
				Green	ZB5 AW0G35	0.042	
				Red	ZB5 AW0G45	0.042	
				Yellow	ZB5 AW0G55	0.042	
				Blue	ZB5 AW0G65	0.042	
		-	-	1	White	ZB5 AW0B11	0.032
					Green	ZB5 AW0M31	0.032
					Red	ZB5 AW0M41	0.032
					Yellow	ZB5 AW0M51	0.032
					Blue	ZB5 AW0M61	0.032
-	-	1	White	ZB5 AW0M12	0.032		
			Green	ZB5 AW0M32	0.032		
			Red	ZB5 AW0M42	0.032		
			Yellow	ZB5 AW0M52	0.032		
			Blue	ZB5 AW0M62	0.032		
	2	-	-	White	ZB5 AW0M13	0.042	
				Green	ZB5 AW0M33	0.042	
				Red	ZB5 AW0M43	0.042	
				Yellow	ZB5 AW0M53	0.042	
				Blue	ZB5 AW0M63	0.042	
1	1	1	White	ZB5 AW0M15	0.042		
			Green	ZB5 AW0M35	0.042		
			Red	ZB5 AW0M45	0.042		
			Yellow	ZB5 AW0M55	0.042		
			Blue	ZB5 AW0M65	0.042		

(1) Can be fitted with additional contact blocks : see page 36018/2.

#### Other versions

Complete bodies with Faston connector terminals (6.35 or 2 x 2.8).  
Please consult your Regional Sales Office.



# Control and signalling units Ø 22

## Harmony® style 5

Illuminated pushbuttons and switches with double insulated bezel

Sub-assemblies ZB5 A : bodies

To combine with heads for integral LED:  
see pages 36017/7 to 36017/9

Complete bodies (fixing collar + single contact block + light block with integral LED) (continued)						
Light source	Supply voltage	Type of contact (1)		Colour of light source	Reference	Weight
						
	V	N/O	N/C			kg
<b>Plug-in connector (2)</b>						
Integral LED 	~ 24	1	-	White	ZB5 AW0B114	0.028
				Green	ZB5 AW0B314	0.028
				Red	ZB5 AW0B414	0.028
				Yellow	ZB5 AW0B514	0.028
				Blue	ZB5 AW0B614	0.028
		-	1	White	ZB5 AW0B124	0.028
				Green	ZB5 AW0B324	0.028
				Red	ZB5 AW0B424	0.028
				Yellow	ZB5 AW0B524	0.028
				Blue	ZB5 AW0B624	0.028
	2	-	White	ZB5 AW0B134	0.035	
			Green	ZB5 AW0B334	0.035	
			Red	ZB5 AW0B434	0.035	
			Yellow	ZB5 AW0B534	0.035	
			Blue	ZB5 AW0B634	0.035	
	1	1	White	ZB5 AW0B154	0.035	
			Green	ZB5 AW0B354	0.035	
			Red	ZB5 AW0B454	0.035	
			Yellow	ZB5 AW0B554	0.035	
			Blue	ZB5 AW0B654	0.035	
~ 48...120	1	-	White	ZB5 AW0G114	0.028	
			Green	ZB5 AW0G314	0.028	
			Red	ZB5 AW0G414	0.028	
			Yellow	ZB5 AW0G514	0.028	
			Blue	ZB5 AW0G614	0.028	
	-	1	White	ZB5 AW0G124	0.028	
			Green	ZB5 AW0G324	0.028	
			Red	ZB5 AW0G424	0.028	
			Yellow	ZB5 AW0G524	0.028	
			Blue	ZB5 AW0G624	0.028	

(1) Can be fitted with additional contact blocks: see page 36018/4.

(2) Connecting cables and connector for plug-in connector electrical blocks: see page 36018/4.





**Other versions**

Complete bodies with Faston connector terminals (6.35 or 2 x 2.8).  
Please consult your Regional Sales Office.



To combine with heads for integral LED:  
see pages 36017/7 to 36017/9

Sub-assemblies ZB5 A : bodies

Complete bodies (fixing collar + single contact block + light block with integral LED) (continued)							
Light source	Supply voltage	Type of contact (1)		Colour of light source	Reference	Weight	
							
	V	N/O	N/C			kg	
<b>Plug-in connector (2) (continued)</b>							
 ZB5 AW00034	Integral LED	~ 48...120	2	-	White	ZB5 AW0G134	0.035
					Green	ZB5 AW0G334	0.035
					Red	ZB5 AW0G434	0.035
					Yellow	ZB5 AW0G534	0.035
					Blue	ZB5 AW0G634	0.035
	~ 230...240	1	1	White	ZB5 AW0G154	0.035	
				Green	ZB5 AW0G354	0.035	
				Red	ZB5 AW0G454	0.035	
				Yellow	ZB5 AW0G554	0.035	
				Blue	ZB5 AW0G654	0.035	
 ZB5 AW00024	~ 230...240	1	-	White	ZB5 AW0M114	0.028	
				Green	ZB5 AW0M314	0.028	
				Red	ZB5 AW0M414	0.028	
				Yellow	ZB5 AW0M514	0.028	
				Blue	ZB5 AW0M614	0.028	
	-	1	1	White	ZB5 AW0M124	0.028	
				Green	ZB5 AW0M324	0.028	
				Red	ZB5 AW0M424	0.028	
				Yellow	ZB5 AW0M524	0.028	
				Blue	ZB5 AW0M624	0.028	
2	-	-	White	ZB5 AW0M134	0.035		
			Green	ZB5 AW0M334	0.035		
			Red	ZB5 AW0M434	0.035		
			Yellow	ZB5 AW0M534	0.035		
			Blue	ZB5 AW0M634	0.035		
1	1	1	White	ZB5 AW0M154	0.035		
			Green	ZB5 AW0M354	0.035		
			Red	ZB5 AW0M454	0.035		
			Yellow	ZB5 AW0M554	0.035		
			Blue	ZB5 AW0M654	0.035		

(1) Can be fitted with additional contact blocks: see page 36018/4.



(2) Connecting cables and connector for plug-in connector electrical blocks: see page 36018/4.

#### Other versions

Complete bodies with Faston connector terminals (6.35 or 2 x 2.8).  
Please consult your Regional Sales Office.

To combine with heads for BA 9s bulbs:  
see pages 36017/7 to 36017/9

**Complete bodies** (fixing collar + single contact block + light block for BA 9s bulb, incandescent, neon or LED)

Description	Light source	Supply voltage V	Type of contact (1)		Colour of light source	Reference	Weight kg
			 N/O	 N/C			
<b>Screw clamp terminal connections</b>							
<b>Direct supply</b>	BA 9s bulb, 2.4 W max. Not included (2)	≤ 250	1	–	–	<b>ZB5 AW061</b>	0.031
			–	1	–	<b>ZB5 AW062</b>	0.031
			2	–	–	<b>ZB5 AW063</b>	0.041
			1	1	–	<b>ZB5 AW065</b>	0.041
<b>Via integral transformer 1.2 VA, 6 V secondary</b>	BA 9s incandescent bulb, included	~ 110...120 50/60 Hz	1	–	–	<b>ZB5 AW031</b>	0.110
			1	1	–	<b>ZB5 AW035</b>	0.119
			1	–	–	<b>ZB5 AW041</b>	0.110
			1	1	–	<b>ZB5 AW045</b>	0.119
			1	–	–	<b>ZB5 AW051</b>	0.110
	BA 9s base fitting LED included	~ 110...120 50/60 Hz	1	1	White	<b>ZB5 AW03D15</b>	0.119
					Green	<b>ZB5 AW03D35</b>	0.119
					Red	<b>ZB5 AW03D45</b>	0.119
					Yellow	<b>ZB5 AW03D55</b>	0.119
					Blue	<b>ZB5 AW03D65</b>	0.119
	~ 230 - 50 Hz ~ 220...240 - 60 Hz	1	1	White	<b>ZB5 AW04D15</b>	0.119	
				Green	<b>ZB5 AW04D35</b>	0.119	
				Red	<b>ZB5 AW04D45</b>	0.119	
				Yellow	<b>ZB5 AW04D55</b>	0.119	
				Blue	<b>ZB5 AW04D65</b>	0.119	
	~ 400 50/60 Hz	1	1	White	<b>ZB5 AW05D15</b>	0.120	
				Green	<b>ZB5 AW05D35</b>	0.120	
				Red	<b>ZB5 AW05D45</b>	0.120	
				Yellow	<b>ZB5 AW05D55</b>	0.120	
				Blue	<b>ZB5 AW05D65</b>	0.120	

(1) Can be fitted with additional contact blocks: see page 36018/2.











(2) Bulb to be ordered separately: see page 36018/14.

**Other versions**

Complete bodies with integral transformer incorporating Faston connector terminals (6.35 or 2 x 2.8).  
Please consult your Regional Sales Office.

To combine with bodies:  
see pages 36017/2 to 36017/6

### Heads for spring return illuminated pushbuttons





Shape of head	Type of push	Colour	Reference	Weight kg
<b>Plain lens</b>				
<b>Only for use with bodies comprising a light source with integral LED</b>				
	Flush	White	ZB5 AW313	0.017
		Green	ZB5 AW333	0.017
		Red	ZB5 AW343	0.017
		Yellow	ZB5 AW353	0.017
		Blue	ZB5 AW363	0.017
	Flush with illuminated ring	White	ZB5 AW913	0.016
		Green	ZB5 AW933	0.016
		Red	ZB5 AW943	0.016
		Yellow	ZB5 AW953	0.016
		Blue	ZB5 AW963	0.016
	Flush with clear boot	White	ZB5 AW513	0.019
		Green	ZB5 AW533	0.019
		Red	ZB5 AW543	0.019
		Yellow	ZB5 AW553	0.019
		Blue	ZB5 AW563	0.019
	Flush for insertion of legend	White	ZB5 AA18	0.018
		Green	ZB5 AA38	0.018
		Red	ZB5 AA48	0.018
		Yellow	ZB5 AA58	0.018
		Blue	ZB5 AA68	0.018
	Projecting	White	ZB5 AW113	0.018
		Green	ZB5 AW133	0.018
		Red	ZB5 AW143	0.018
		Yellow	ZB5 AW153	0.018
		Blue	ZB5 AW163	0.018
	Flush (legend can be inserted)	White	ZB5 CW313	0.023
		Green	ZB5 CW333	0.023
		Red	ZB5 CW343	0.023
		Yellow	ZB5 CW353	0.023
		Blue	ZB5 CW363	0.023
	Projecting (legend can be inserted)	White	ZB5 CW113	0.024
		Green	ZB5 CW133	0.024
		Red	ZB5 CW143	0.024
		Yellow	ZB5 CW153	0.024
		Blue	ZB5 CW163	0.024
<b>Grooved lens (For use in bright ambient light conditions - outdoors in sunlight, for example)</b>				
<b>Only for use with bodies comprising a light source with integral LED</b>				
	Flush	White	ZB5 AW313S	0.017
		Green	ZB5 AW333S	0.017
		Red	ZB5 AW343S	0.017
		Yellow	ZB5 AW353S	0.017
		Blue	ZB5 AW363S	0.017
<b>Plain lens (1)</b>				
	Flush	White	ZB5 AW31	0.018
		Green	ZB5 AW33	0.018
		Red	ZB5 AW34	0.018
		Yellow	ZB5 AW35	0.018
		Blue	ZB5 AW36	0.018
		Clear	ZB5 AW37	0.018
			Projecting	White
Green	ZB5 AW13			0.017
Red	ZB5 AW14			0.017
Yellow	ZB5 AW15			0.017
Blue	ZB5 AW16			0.017
Clear	ZB5 AW17			0.017
<b>Grooved lens (1) (For use in bright ambient light conditions - outdoors in sunlight, for example)</b>				
	Flush	White	ZB5 AW31S	0.018
		Green	ZB5 AW33S	0.018
		Red	ZB5 AW34S	0.018
		Yellow	ZB5 AW35S	0.018
		Blue	ZB5 AW36S	0.018
		Clear	ZB5 AW37S	0.018

(1) Only for use with bodies comprising a light source with BA 9s bulb (incandescent, neon or LED).





To combine with bodies:  
see pages 36017/2 to 36017/6

Sub-assemblies ZB5 A : heads

### Heads for illuminated "push-push to release" pushbuttons (1)

Shape of head	Type of push	Colour of lens	Reference	Weight kg
Only for use with bodies comprising a light source with integral LED 				
	Flush	White	ZB5 AH013	0.017
		Green	ZB5 AH033	0.017
		Red	ZB5 AH043	0.017
		Yellow	ZB5 AH053	0.017
		Blue	ZB5 AH063	0.017
	Projecting	White	ZB5 AH13	0.017
		Green	ZB5 AH33	0.017
		Red	ZB5 AH43	0.017
		Yellow	ZB5 AH53	0.017
		Blue	ZB5 AH63	0.017
	Flush	White	ZB5 CH313	0.018
		Green	ZB5 CH333	0.018
		Red	ZB5 CH343	0.018
		Yellow	ZB5 CH353	0.018
		Blue	ZB5 CH363	0.018

### Heads with pilot light for double-headed, spring return pushbuttons (IP 40) (2)

Shape of head	Description	Colour of pushes	Colour of pilot light	Reference	Weight kg
Only for use with bodies comprising a light source with integral LED (without function marking on push) 					
	1 flush push 1 central pilot light 1 flush push	Black	Clear (3)	ZB5 AW812743	0.022
		Red	Clear (3)	ZB5 AW813743	0.022
		Green	Clear (3)	ZB5 AW813743	0.022
		Red	Clear (3)	ZB5 AW813743	0.022
	1 flush push 1 central pilot light 1 projecting push	White	Clear (3)	ZB5 AW811723	0.022
		Black	Clear (3)	ZB5 AW812743	0.021
		Red	Clear (3)	ZB5 AW812743	0.021
		Green	Clear (3)	ZB5 AW833743	0.021
	1 flush push 1 central pilot light 1 projecting push	Red	Clear (3)	ZB5 AW833743	0.021
		White	Clear (3)	ZB5 AW831723	0.021
		Black	Clear (3)	ZB5 AW831723	0.021

### Only for use with bodies comprising a light source with integral LED (with function marking on push)

	1 flush push (marked "I") 1 central pilot light 1 flush push (marked "O")	Black	Clear (3)	ZB5 AW822743	0.022
		Red	Clear (3)	ZB5 AW822743	0.022
		Green	Clear (3)	ZB5 AW823743	0.022
		Red	Clear (3)	ZB5 AW823743	0.022
	1 flush push (marked "I") 1 central pilot light 1 projecting push (marked "O")	White	Clear (3)	ZB5 AW821723	0.021
		Black	Clear (3)	ZB5 AW822743	0.021
		Red	Clear (3)	ZB5 AW822743	0.021
		Green	Clear (3)	ZB5 AW843743	0.021
	1 flush push (marked "I") 1 central pilot light 1 projecting push (marked "O")	Red	Clear (3)	ZB5 AW841723	0.021
		White	Clear (3)	ZB5 AW841723	0.021
		Black	Clear (3)	ZB5 AW841723	0.021

(1) Maximum of 1 row of 2 contact blocks on associated body/fixing collar sub-assembly.

(2) NEMA type 1, for a head with IP 66 degree of protection (NEMA type 4X) fit a clear sealing boot ZBW 008: see page 36018/15.

(3) Colour of centrally positioned pilot light determined by the colour of the LED incorporated in the body assembly.

814657



ZB5 AW833743

814568



ZB5 AW823743

814569



ZB5 AW843743

To combine with bodies:  
see pages 36017/2 to 36017/6



ZB5 AW743

## Heads for Ø 40 latching mushroom head pushbuttons

Shape of head	Type of push	Colour of push	Reference	Weight kg
	Turn to release	White	ZB5 AW713	0,022
		Green	ZB5 AW733	0.022
		Red	ZB5 AW743	0.022
		Yellow	ZB5 AW753	0.022
		Blue	ZB5 AW763	0.022

## Heads for illuminated selector switches with standard handle (1)

Shape of head	Number and type of positions	Colour of handle	Reference	Weight kg
Only for use with bodies comprising a light source with integral LED				
	2 - stay put	White	ZB5 AK1213	0.021
		Green	ZB5 AK1233	0.021
		Red	ZB5 AK1243	0.021
		Yellow	ZB5 AK1253	0.021
		Blue	ZB5 AK1263	0.021
	2 - spring return from right to left	White	ZB5 AK1413	0.021
		Green	ZB5 AK1433	0.021
		Red	ZB5 AK1443	0.021
		Yellow	ZB5 AK1453	0.021
		Blue	ZB5 AK1463	0.021
	3 - stay put	White	ZB5 AK1313	0.021
		Green	ZB5 AK1333	0.021
		Red	ZB5 AK1343	0.021
		Yellow	ZB5 AK1353	0.021
		Blue	ZB5 AK1363	0.021
	3 - spring return to centre	White	ZB5 AK1513	0.021
		Green	ZB5 AK1533	0.021
		Red	ZB5 AK1543	0.021
		Yellow	ZB5 AK1553	0.021
		Blue	ZB5 AK1563	0.021
	3 - spring return from right to centre	White	ZB5 AK1813	0.021
		Green	ZB5 AK1833	0.021
		Red	ZB5 AK1843	0.021
		Yellow	ZB5 AK1853	0.021
		Blue	ZB5 AK1863	0.021
	3 - spring return from left to centre	White	ZB5 AK1713	0.021
		Green	ZB5 AK1733	0.021
		Red	ZB5 AK1743	0.021
		Yellow	ZB5 AK1753	0.021
		Blue	ZB5 AK1763	0.021

Protected LED



ZB5 AK1213



ZB5 AK1463

(1) NEMA type 13.

# Control and signalling units Ø 22

Harmony® style 5

Pushbuttons, switches and pilot lights with double insulated bezel

Separate components and accessories : electrical blocks

814584



ZBE 101

814585



ZBE 102

814586



ZBE 203

814587



ZBE 204

## Contact blocks with screw clamp terminal connections (1)

Description	Type of contact		Sold in lots of	Unit reference	Weight kg
	N/O	N/C			
Standard single contact blocks	1	–	5	ZBE 101	0.011
	–	1	5	ZBE 102	0.011
Standard double contact blocks	2	–	5	ZBE 203	0.020
	–	2	5	ZBE 204	0.020
Special contact blocks for low power switching with gold flashed contacts	1	1	5	ZBE 205	0.020
	1	–	5	ZBE 1016	0.012
Special contact blocks for low power switching with gold flashed contacts and dust protection (2)	–	1	5	ZBE 1026	0.012
	1	–	5	ZBE 1016P	0.012
	–	1	5	ZBE 1026P	0.012

## Body/fixing collar

For use with	Sold in lots of	Unit reference	Weight kg
Electrical blocks (contact or light)	10	ZB5 AZ009	0.006

814588



ZB5 AZ009

## Clip-on legend holders for electrical blocks with screw clamp terminal connections

Identification of an XB5 A control or signalling unit	10	ZBZ 001	0.001
---	----	---------	-------

814582

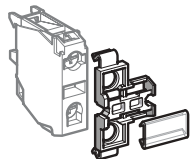

ZBZ 001

## Sheet of 50 blank legends

Legend holder ZBY 001	10	ZBY 001	0.023
-----------------------	----	---------	-------

## “SIS Label” labelling software (for legends ZBY 001)

Legend design for English, French, German, Italian, Spanish	1	XBY 2U	0.100
---	---	--------	-------

563527

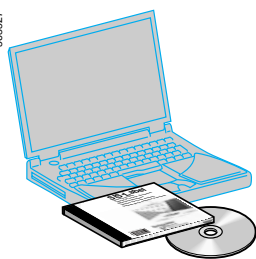

XBY 2U

- (1) The contact blocks enable variable composition of body sub-assemblies. Maximum number of rows possible: 3.  
Either 3 rows of 3 single contacts or 1 row of 3 double contacts + 1 row of 3 single contacts (double contact blocks occupy 2 rows).
- (2) It is not possible to fit an additional contact block on the back of these blocks.

**Other versions** Contact blocks with Faston connector terminals (6.35 or 2 x 2.8). Please consult your Regional Sales Office.



## Light blocks with screw clamp terminals

Description	Supply voltage V	Colour of light source	Sold in lots of	Unit reference	Weight kg
Integral LED (to combine with heads for integral LED) <b>Protected LED</b>	≈ 12	White	5	ZBV J1 (1)	0.017
		Green	5	ZBV J3 (1)	0.017
		Red	5	ZBV J4 (1)	0.017
		Yellow	5	ZBV J5 (1)	0.017
		Blue	5	ZBV J6	0.017
	≈ 24	White	5	ZBV B1 (1)	0.017
		Green	5	ZBV B3 (1)	0.017
		Red	5	ZBV B4 (1)	0.017
		Yellow	5	ZBV B5 (1)	0.017
		Blue	5	ZBV B6 (1)	0.017
	≈ 24...120	White	5	ZBV BG1	0.017
		Green	5	ZBV BG3	0.017
		Red	5	ZBV BG4	0.017
		Yellow	5	ZBV BG5	0.017
		Blue	5	ZBV BG6	0.017
≈ 48...120	White	5	ZBV G1 (1)	0.017	
	Green	5	ZBV G3 (1)	0.017	
	Red	5	ZBV G4 (1)	0.017	
	Yellow	5	ZBV G5 (1)	0.017	
	Blue	5	ZBV G6 (1)	0.017	
≈ 230...240	White	5	ZBV M1 (1)	0.017	
	Green	5	ZBV M3 (1)	0.017	
	Red	5	ZBV M4 (1)	0.017	
	Yellow	5	ZBV M5 (1)	0.017	
	Blue	5	ZBV M6 (1)	0.017	
Direct supply for BA 9s bulb, 2.4 W max. Not included (1)	≤ 250	-	5	ZBV 6	0.016



## LED suppressors

For use with	Supply voltage V	Reference	Weight kg
Light blocks with integral LED fitted with screw clamp terminal connections	≈ 120	ZBZ VG	0.010
	≈ 230	ZBZ VM	0.010



## Body/fixing collar

For use with	Sold in lots of	Unit reference	Weight kg
Electrical block (contact or light)	10	ZB5 AZ009	0.006

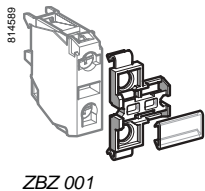

## Clip-on legend holders for electrical blocks with screw clamp terminal connections

Identification of an XB5 A control or signalling unit	10	ZBZ 001	0.001
---	----	---------	-------

## Sheet of 50 blank legends

Legend holder ZBZ 001	10	ZBY 001	0.023
-----------------------	----	---------	-------

## "SIS Label" labelling software (for legends ZBY 001)

Legend design for English, French, German, Italian, Spanish	1	XBY 2U	0.100
---	---	--------	-------

(1) To order a "high luminosity" version, add the suffix **S** to the reference (example: **ZBV B5S** for a yellow, 24 V, high luminosity light block).

(2) Bulb to be ordered separately: see page 36018/14.

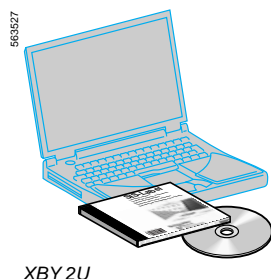

**Other versions** Light blocks with Faston connector terminals (6.35 or 2 x 2.8). Please consult your Regional Sales Office.

814597



ZBE 1014

814598



ZBE 1024

814599



ZBV Bø4

563169

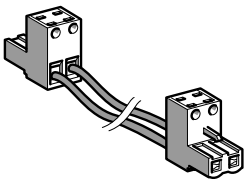

APE 1C2250

563160

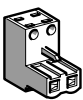

APE 1PAD21

814600



ZB5 AZ009

## Contact blocks for plug-in connector

Description	Type of contact		Sold in lots of	Unit reference	Weight
					kg
Standard contact blocks	1	–	5	ZBE 1014	0.009
	–	1	5	ZBE 1024	0.009

## Light blocks for plug-in connector

Description	Supply voltage V	Colour of light source	Sold in lots of	Unit reference	Weight
Integral LED (to combine with heads for integral LED)	≈ 24	White	5	ZBV B14	0.016
		Green	5	ZBV B34	0.016
		Red	5	ZBV B44	0.016
		Yellow	5	ZBV B54	0.016
		Blue	5	ZBV B64	0.016
	≈ 48...120	White	5	ZBV G14	0.016
		Green	5	ZBV G34	0.016
		Red	5	ZBV G44	0.016
		Yellow	5	ZBV G54	0.016
		Blue	5	ZBV G64	0.016
≈ 230...240	White	5	ZBV M14	0.016	
	Green	5	ZBV M34	0.016	
	Red	5	ZBV M44	0.016	
	Yellow	5	ZBV M54	0.016	
	Blue	5	ZBV M64	0.016	

Protected  
LED

## Connecting cables and connector

Description	Number of connectors	Wire c.s.a. mm <sup>2</sup>	Length mm	Sold in lots of	Unit reference	Weight
Cables with connectors 2-pin, 5.08 mm pitch	1	0.75	500	8	APE 1C2150	0.120
	2	0.75	500	8	APE 1C2250	0.180
Self-stripping connector 2-pin, 5.08 mm pitch	–	0.75	–	16	APE 1PAD21	0.080
Spring terminal connector 2-pin, 5.08 mm pitch	–	0.2 to 2.5	–	10	APE 1PRE21	0.003

## Body/fixing collar

For use with	Sold in lots of	Unit reference	Weight
Electrical block (contact or light)	10	ZB5 AZ009	0.006





ZBE 701



ZBE 702



ZBV B07

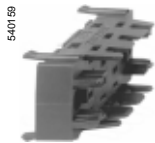

ZBZ 010



ZB5 AZ079

## Contact blocks for printed circuit board connection (1)

Description	Type of contact		Sold in lots of	Unit reference	Weight kg
	N/O	N/C			
Standard contact blocks	1	–	10	ZBE 701	0.002
	–	1	10	ZBE 702	0.002
Special contact blocks for low power switching (with gold flashed contacts and dust protection)	1	–	10	ZBE 7016	0.003
	–	1	10	ZBE 7026	0.003

## Light blocks for printed circuit board connection (1)

Description	Supply voltage V	Colour of LED	Sold in lots of	Unit reference	Weight kg
Integral LED (to combine with heads for integral LED)	≈ 24	White	5	ZBV B17	0.004
		Green	5	ZBV B37	0.004
		Red	5	ZBV B47	0.004
		Yellow	5	ZBV B57	0.004
		Blue	5	ZBV B67	0.004

Protected  
LED

## Adaptor (socket) for printed circuit board connection

For use with	Thickness of printed circuit board mm	Sold in lots of	Unit reference	Weight kg
Electrical block (contact or light)	1.6 ± 0.2	10	ZBZ 010	0.008
	2.2 ± 0.2	10	ZBZ 011	0.008
	3.2 ± 0.2	10	ZBZ 012	0.008

## Accessories specifically for printed circuit board mounting (1)

Description	For use with	Sold in lots of	Unit reference	Weight kg
Fixing collar/pillar	Printed circuit board support	10	ZB5 AZ079	0.003
Fixing screw for printed circuit board	Fixing collar/pillar ZB5 AZ079	10	ZBZ 006	0.011

(1) For details of support drilling and of printed circuit board: see page 36021/9.  
Must be used in conjunction with adaptor (socket) ZBZ 010.

## Control and signalling units Ø 22

## Harmony® style 5

Pushbuttons, switches and pilot lights with double insulated bezel

Separate components and accessories : for heads

## Pushbutton caps - unmarked

For use with	Type of push	Colour	Sold in lots of	Unit reference	Weight kg
ZB5 AA0 circular pushbutton heads supplied without cap	Flush	White	10	ZBA 1	0.001
		Black	10	ZBA 2	0.001
		Green	10	ZBA 3	0.001
		Red	10	ZBA 4	0.001
		Yellow	10	ZBA 5	0.001
		Blue	10	ZBA 6	0.001
		6 colours (1)	1	ZBA 9	0.006
	Projecting	White	10	ZBL 1	0.001
		Black	10	ZBL 2	0.001
		Green	10	ZBL 3	0.001
		Red	10	ZBL 4	0.001
		Yellow	10	ZBL 5	0.001
		Blue	10	ZBL 6	0.001
6 colours (1)		1	ZBL 9	0.006	

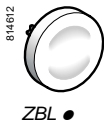
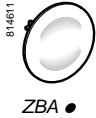

## Pushbutton caps - marked (3) (sold in lots of 10)

For use with	Type of push	Marking		Colour of cap	Unit reference	Weight kg
		Text	Colour			
ZB5 AA0 circular pushbutton heads supplied without cap	Flush	I (2)	White	Green	ZBA 331	0.001
			Black	White	ZBA 131	0.001
		II	White	Green	ZBA 336	0.001
			Black	White	ZBA 136	0.001
		III	White	Green	ZBA 337	0.001
			Black	White	ZBA 137	0.001
		IV	White	Green	ZBA 338	0.001
			Black	White	ZBL 138	0.001
		START (2)	White	Green	ZBA 333	0.001
			Black	White	ZBA 133	0.001
		ON	White	Green	ZBA 341	0.001
			Black	White	ZBA 141	0.001
		MARCHE	White	Green	ZBA 342	0.001
			Black	White	ZBA 142	0.001
		UP (2)	Black	White	ZBA 343	0.001
		DOWN (2)	White	Black	ZBA 344	0.001
		⊕ (2)	White	Black	ZBA 245	0.001
			Black	White	ZBA 145	0.001
		↑	White	Black	ZBA 335	0.001
			Black	White	ZBA 334	0.001
		O (2)	White	Red	ZBA 432	0.001
			Black	White	ZBA 232	0.001
		ARRET	White	Red	ZBA 433	0.001
			Black	White	ZBA 233	0.001
		STOP (2)	White	Red	ZBA 434	0.001
			Black	White	ZBA 234	0.001
		OFF	White	Red	ZBA 435	0.001
			Black	White	ZBA 235	0.001
		⬇	White	Green	ZBA 346	0.001
		R (2)	White	Blue	ZBA 639	0.001
		+	White	Black	ZBA 2934	0.001
		-	White	Black	ZBA 2935	0.001



(1) Set of 6 different coloured caps: white, black, green, red, yellow, blue.

(2) Double injection moulded marking.

(3) Can be clipped-in at 90° steps, through 360°.

## Standard (30 x 40 mm) legend holders for 8 x 27 mm legends (1)

Description	Legend		Sold in lots of	Unit reference	Weight kg		
	Colour	Marking					
<b>Without legend</b>	–	–	10	ZBZ 32	0,001		
<b>With blank legend</b> (for engraving)	Black or red background	–	10	ZBY 2101	0.002		
	White or yellow background	–	10	ZBY 4101	0.002		
<b>With 8 x 27 mm legend</b> (with International marking)	Black or red background (2)	O (black background)	1	ZBY 2146	0.002		
		O (red background)	1	ZBY 2931	0.002		
		I	1	ZBY 2147	0.002		
		II	1	ZBY 2148	0.002		
		O-I	1	ZBY 2178	0.002		
		I-II	1	ZBY 2179	0.002		
		I-O-II	1	ZBY 2186	0.002		
		AUTO	1	ZBY 2115	0.002		
		STOP	1	ZBY 2304	0.002		
		<b>With 8 x 27 mm legend</b> (with French language marking)	Black or red background (2)	ARRET (red background)	1	ZBY 2104	0.002
				ARRET (black background)	1	ZBY 0104	0.002
				ARRET GENERAL	1	ZBY 2129	0.002
				ARRET REARMEMENT	1	ZBY 2133	0.002
				ARRET D'URGENCE	1	ZBY 2130	0.002
ARRET-MARCHE	1			ZBY 2166	0.002		
ARRIERE	1			ZBY 2106	0.002		
AUTO CYCLE-CYCLE	1			ZBY 2198	0.002		
AUTO CYCLE-MAIN	1			ZBY 2199	0.002		
AUTO-MAIN	1			ZBY 2164	0.002		
AUTO-O-MAIN	1			ZBY 2185	0.002		
AVANT	1			ZBY 2105	0.002		
AVANT-O-ARRIERE	1			ZBY 2184	0.002		
C-P-C-NORMAL	1			ZBY 2165	0.002		
CYCLE-MAIN	1			ZBY 2197	0.002		
DECLENCHEMENT	1			ZBY 2132	0.002		
DEFAUT (black background)	1			ZBY 2134	0.002		
DEFAUT (red background)	1			ZBY 2135	0.002		
DEPART CYCLE	1			ZBY 2195	0.002		
DESCENTE	1			ZBY 2108	0.002		
DROITE	1	ZBY 2109	0.002				
ENCLENCHEMENT	1	ZBY 2131	0.002				
EN SERVICE	1	ZBY 2111	0.002				
FERMETURE	1	ZBY 2114	0.002				
GAUCHE	1	ZBY 2110	0.002				
HORS SERVICE	1	ZBY 2112	0.002				
HORS-EN	1	ZBY 2167	0.002				
LENT	1	ZBY 2127	0.002				
MAIN	1	ZBY 2116	0.002				
MARCHE	1	ZBY 2103	0.002				
MONTEE	1	ZBY 2107	0.002				
OUVERTURE	1	ZBY 2113	0.002				
PHASE / PHASE	1	ZBY 2196	0.002				
REARMEMENT (red background)	1	ZBY 2123	0.002				
REARMEMENT (black background)	1	ZBY 0123	0.002				
SOUS TENSION	1	ZBY 2126	0.002				
VITE	1	ZBY 2128	0.002				

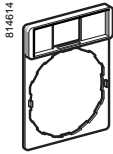

ZBZ 32

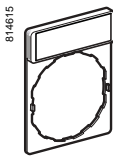

ZBY 101

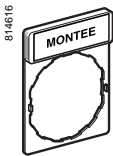

ZBY 2107

(1) For legends, see pages 36018/9 to 36018/11.

(2) "Start" functions: white letters on black background. "Stop" functions: white letters on red background (unless otherwise specified above).

## Control and signalling units Ø 22

Harmony® style 5

Pushbuttons, switches and pilot lights with double insulated bezel

Separate components and accessories : for heads

## Standard (30 x 40 mm) legend holders for 8 x 27 mm legends (continued)

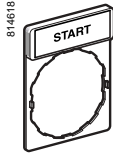

ZBY 2303

Description	Legend		Reference	Weight kg
	Colour	Marking		
With legend (with English language marking)	Black or red background (1)	AUTO-HAND	ZBY 2364	0.002
		AUTO-O-HAND	ZBY 2385	0.002
		CLOSE	ZBY 2314	0.002
		DOWN	ZBY 2308	0.002
		EMERGENCY STOP	ZBY 2330	0.002
		FAST	ZBY 2328	0.002
		FORWARD	ZBY 2305	0.002
		HAND	ZBY 2316	0.002
		HAND-OFF-AUTO	ZBY 2387	0.002
		INCH	ZBY 2321	0.002
		LEFT	ZBY 2310	0.002
		OFF	ZBY 2312	0.002
		OFF-ON	ZBY 2167	0.002
		ON	ZBY 2311	0.002
		OPEN	ZBY 2313	0.002
		POWER ON	ZBY 2326	0.002
		RESET (red background)	ZBY 2323	0.002
		RESET (black background)	ZBY 2322	0.002
		REVERSE	ZBY 2306	0.002
		RIGHT	ZBY 2309	0.002
		RUN	ZBY 2334	0.002
		SLOW	ZBY 2327	0.002
		START	ZBY 2303	0.002
		STOP-START	ZBY 2366	0.002
		UP	ZBY 2307	0.002

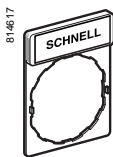

ZBY 2228

With legend (with German language marking)	Black or red background(1)	AB	ZBY 2208	0.002
		AUF	ZBY 2207	0.002
		AUS	ZBY 2204	0.002
		AUS-EIN	ZBY 2266	0.002
		AUS-IN BETRIEB	ZBY 2267	0.002
		AUS-RUCKSTELLUNG	ZBY 2233	0.002
		AUSSCHALTEN	ZBY 2232	0.002
		AUTO-HAND	ZBY 2364	0.002
		AUTO-O-HAND	ZBY 2385	0.002
		AUTOZYKL-HAND	ZBY 2299	0.002
		AUTOZYKL-1 ZYKL	ZBY 2298	0.002
		C-P-C-NORMAL	ZBY 2265	0.002
		EIN	ZBY 2203	0.002
		EINSCHALTEN	ZBY 2231	0.002
		HAND	ZBY 2316	0.002
		LANGSAM	ZBY 2227	0.002
		LINKS	ZBY 2210	0.002
		NOT-AUS (red background)	ZBY 2230	0.002
		NOT-AUS (yellow background)	ZBY 22420001	0.002
		NOT-HALT	ZBY 2229	0.002
		ÖFFNEN	ZBY 2213	0.002
		RECHTS	ZBY 2209	0.002
		RUCKSTELLUNG	ZBY 2223	0.002
		SCHLIESSEN	ZBY 2214	0.002
		SCHNELL	ZBY 2228	0.002
		SPANNUNG EIN	ZBY 2226	0.002
		STEUERUNG AUS	ZBY 2212	0.002
		STEUERUNG EIN	ZBY 2211	0.002
		STORUNG (black background)	ZBY 2234	0.002
		STORUNG (red background)	ZBY 2235	0.002
		VOR	ZBY 2205	0.002
		VOR-O-ZURUCK	ZBY 2284	0.002
		ZURUCK	ZBY 2206	0.002
		ZYKLUS-HAND	ZBY 2297	0.002
		ZYKLUSSTART	ZBY 2295	0.002

(1) "Start" functions: white letters on black background. "Stop" functions: white letters on red background (unless otherwise specified above).

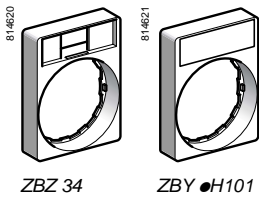

ZBZ 34

ZBY 2H101

**30 x 40 mm legend holders (flush mounting with bezel) for 8 x 27 mm legends**

Description	For use with	Colour	Sold in lots of	Unit reference	Weight kg
Without legend	Circular heads	–	10	ZBZ 34	0.003
	Square heads	–	10	ZBC Z34	0.002
With blank legend	Circular heads	Black or red background	10	ZBY 2H101	0.004
		White or yellow background	10	ZBY 4H101	0.004
	Square heads	Black or red background	10	ZBC Y2H101	0.002
		White or yellow background	10	ZBC Y4H101	0.002

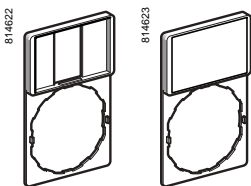

ZBZ 33

ZBY 6101

**Standard (30 x 50 mm) legend holders for 18 x 27 mm legends**

Description	For use with	Colour	Sold in lots of	Unit reference	Weight kg
Without legend	Circular and square heads	–	10	ZBZ 33	0.001
With blank legend	Circular and square heads	Black or red background	10	ZBY 6101	0.002
		White or yellow background	10	ZBY 6102	0.002

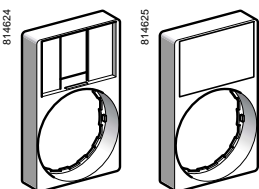

ZBZ 35

ZBY 6H101

**30 x 50 mm legend holders (flush mounting with bezel) for 18 x 27 mm legends**

Description	For use with	Colour	Sold in lots of	Unit reference	Weight kg
Without legend	Circular heads	–	10	ZBZ 35	0.003
	Square heads	–	10	ZBC Z35	0.002
With blank legend	Circular heads	Black or red background	10	ZBY 6H101	0.004
		White or yellow background	10	ZBY 6H102	0.004
	Square heads	Black or red background	10	ZBC Y6H101	0.003
		White or yellow background	10	ZBC Y6H102	0.003

**Legends for engraving**

Description mm	For use with	Colour	Sold in lots of	Unit reference	Weight kg
8 x 27	30 x 40 mm legend holders	Black or red background	10	ZBY 0101	0.001
		White or yellow background	10	ZBY 0102	0.001
18 x 27	30 x 50 mm legend holders	Black or red background	10	ZBY 5101	0.001
		White or yellow background	10	ZBY 5102	0.001

**Sheets of peel-off legends (with backing board and protective transparent cover)**

Description	For use with	Sold in lots of	Unit reference	Weight kg
Sheet of 76 8 x 27 mm legends	30 x 40 mm legend holders ZBZ 32 and ZBZ 34	10	ZBY 4100	0.043
Sheet of 40 18 x 27 mm legends	30 x 50 mm legend holders ZBZ 33 and ZBZ 35	10	ZBY 5100	0.044

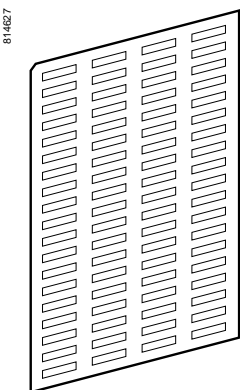

ZBY 4100

**“SIS Label” labelling software**

Application	Reference	Weight kg
Legend design for English, French, German, Italian, Spanish	XBY 2U	0.100

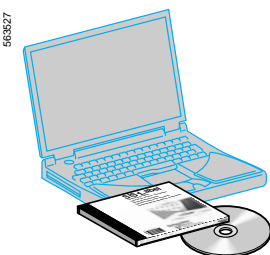

XBY 2U

## Control and signalling units Ø 22

Harmony® style 5

Pushbuttons, switches and pilot lights with double insulated bezel

Separate components and accessories : for heads

**8 x 27 mm marked legends** (for 30 x 40 mm legend holders ZBZ 32 and ZBZ 34)

Colour	Marking	Reference	Weight kg		
Black or red background (1)	International	O (black background)	ZBY 02146	0,001	
		O (red background)	ZBY 02931	0.001	
		I	ZBY 02147	0.001	
		II	ZBY 02148	0.001	
		O-I	ZBY 02178	0.001	
		I-II	ZBY 02179	0.001	
		I-O-II	ZBY 02186	0.001	
		AUTO	ZBY 02115	0.001	
		STOP	ZBY 02304	0.001	
		French	ARRET (red background)	ZBY 02104	0.001
			ARRET (black background)	ZBY 00104	0.001
			ARRET GENERAL	ZBY 02129	0.001
ARRET REARMEMENT	ZBY 02133		0.001		
ARRET D'URGENCE	ZBY 02130		0.001		
ARRET-MARCHE	ZBY 02166		0.001		
ARRIERE	ZBY 02106		0.001		
AUTO CYCLE-CYCLE	ZBY 02198		0.001		
AUTO CYCLE-MAIN	ZBY 02199		0.001		
AUTO-MAIN	ZBY 02164		0.001		
AUTO-O-MAIN	ZBY 02185		0.001		
AVANT	ZBY 02105		0.001		
AVANT-O-ARRIERE	ZBY 02184		0.001		
C-P-C-NORMAL	ZBY 02165		0.001		
CYCLE-MAIN	ZBY 02197		0.001		
DECLenchement	ZBY 02132		0.001		
DEFAUT (black background)	ZBY 02134		0.001		
DEFAUT (red background)	ZBY 02135		0.001		
DEPART CYCLE	ZBY 02195		0.001		
DESCENTE	ZBY 02108		0.001		
DROITE	ZBY 02109		0.001		
ENCLenchement	ZBY 02131		0.001		
EN SERVICE	ZBY 02111		0.001		
FERMETURE	ZBY 02114		0.001		
GAUCHE	ZBY 02110		0.001		
HORS SERVICE	ZBY 02112		0.001		
HORS-EN	ZBY 02167		0.001		
LENT	ZBY 02127		0.001		
MAIN	ZBY 02116		0.001		
MARCHE	ZBY 02103		0.001		
MONTEE	ZBY 02107		0.001		
OUVERTURE	ZBY 02113		0.001		
PHASE / PHASE	ZBY 02196		0.001		
REARMEMENT (red background)	ZBY 02123		0.001		
REARMEMENT (black background)	ZBY 00123		0.001		
SOUS TENSION	ZBY 02126		0.001		
VITE	ZBY 02128		0.001		

(1) "Start" functions: white letters on black background. "Stop" functions: white letters on red background (unless otherwise specified above).

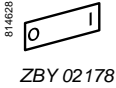

**8 x 27 mm marked legends** (for 30 x 40 mm legend holders ZBZ 32 and ZBZ 34) (continued)

Colour	Marking	Reference	Weight kg			
Black or red background (1)	English	AUTO-HAND	ZBY 02364	0,001		
		AUTO-O-HAND	ZBY 02385	0.001		
		CLOSE	ZBY 02314	0.001		
		DOWN	ZBY 02308	0.001		
		EMERGENCY STOP	ZBY 02330	0.001		
		FAST	ZBY 02328	0.001		
		FORWARD	ZBY 02305	0.001		
		HAND	ZBY 02316	0.001		
		HAND-OFF-AUTO	ZBY 02387	0.001		
		INCH	ZBY 02321	0.001		
		LEFT	ZBY 02310	0.001		
		OFF	ZBY 02312	0.001		
		OFF-ON	ZBY 02367	0.001		
		ON	ZBY 02311	0.001		
		OPEN	ZBY 02313	0.001		
		POWER ON	ZBY 02326	0.001		
		RESET (red background)	ZBY 02323	0.001		
		RESET (black background)	ZBY 02322	0.001		
		REVERSE	ZBY 02306	0.001		
		RIGHT	ZBY 02309	0.001		
		RUN	ZBY 02334	0.001		
		SLOW	ZBY 02327	0.001		
		START	ZBY 02303	0.001		
		STOP-START	ZBY 02366	0.001		
		UP	ZBY 02307	0.001		
		German	German	AB	ZBY 02208	0.001
				AUF	ZBY 02207	0.001
				AUS	ZBY 02204	0.001
				AUS-EIN	ZBY 02266	0.001
				AUS-IN BETRIEB	ZBY 02267	0.001
				AUS-RUCKSTELLUNG	ZBY 02233	0.001
				AUSSCHALLEN	ZBY 02232	0.001
AUTO-HAND	ZBY 02364			0.001		
AUTO-O-HAND	ZBY 02385			0.001		
AUTOZYKL-HAND	ZBY 02299			0.001		
AUTOZYKL- 1 ZYKL	ZBY 02298			0.001		
C-P-C-NORMAL	ZBY 02265			0.001		
EIN	ZBY 02203			0.001		
EINSCHALTEN	ZBY 02231			0.001		
HAND	ZBY 02316			0.001		
LANGSAM	ZBY 02227			0.001		
LINKS	ZBY 02210			0.001		
NOT-AUS (red background)	ZBY 02230			0.001		
NOT-AUS (yellow background)	ZBY 022420001			0.001		
NOT-HALT	ZBY 02229			0.001		
ÖFFNEN	ZBY 02213			0.001		
RECHTS	ZBY-02209			0.001		
RUCKSTELLUNG	ZBY-02223			0.001		
SCHLIESSEN	ZBY-02214			0.001		
SCHNELL	ZBY-02228			0.001		
SPANNUNG EIN	ZBY-02226			0.001		
STEUERUNG AUS	ZBY-02212			0.001		
STEUERUNG EIN	ZBY-02211			0.001		
STORUNG (black background)	ZBY-02234			0.001		
STORUNG (red background)	ZBY-02235			0.001		
VOR	ZBY-02205			0.001		
VOR-O-ZURUCK	ZBY-02284			0.001		
ZURUCK	ZBY-02206			0.001		
ZYKLUS-HAND	ZBY-02297			0.001		
ZYKLUSSTART	ZBY-02295			0.001		

(1) "Start" functions: white letters on black background. "Stop" functions: white letters on red background (unless otherwise specified above).

814633

START

ZBY 02303

814632

SCHNELL

ZBY 02228

# Control and signalling units Ø 22

## Harmony® style 5

Pushbuttons, switches and pilot lights with double insulated bezel

Separate components and accessories : for heads

### Legends for pushbuttons, switches and pilot lights XB5 A

Description	Marking		Sold in lots of	Unit reference	Weight kg	
Sheets of 66 circular peel-off transparent self-adhesive legends	Without		10	ZBY 1101	0.017	
	International	O	10	ZBY 1146	0.017	
Strips of 66 circular peel-off transparent self-adhesive legends		I	10	ZBY 1147	0.017	
		II	10	ZBY 1148	0.017	
		III	10	ZBY 1149	0.017	
		STOP	10	ZBY 1304	0.017	
		↑	10	ZBY 1912	0.017	
	French	ARRET		10	ZBY 1104	0.017
		ARRIERE		10	ZBY 1106	0.017
		AUTO		10	ZBY 1115	0.017
		AVANT		10	ZBY 1105	0.017
		DESCENTE		10	ZBY 1108	0.017
		MAIN		10	ZBY 1116	0.017
		MARCHE		10	ZBY 1103	0.017
		MONTEE		10	ZBY 1107	0.017
	English	HAND		10	ZBY 1316	0.017
		OFF		10	ZBY 1312	0.017
		ON		10	ZBY 1311	0.017
		START		10	ZBY 1303	0.017
German	AB		10	ZBY 1208	0.017	
	AUF		10	ZBY 1207	0.017	
	AUS		10	ZBY 1204	0.017	
	EIN		10	ZBY 1203	0.017	
	ZU		10	ZBY 1214	0.017	
Strip of 66 square peel-off transparent self-adhesive legends	Without		10	ZBC Y1101	0.017	

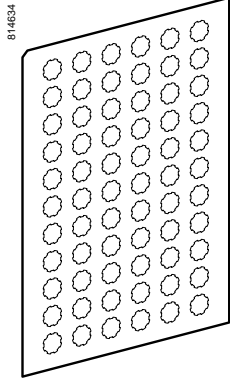

ZBY 1101

### “SIS Label” labelling software

Application	Unit reference	Weight kg
Legend design for English, French, German, Italian, Spanish	XBY 2U	0.100

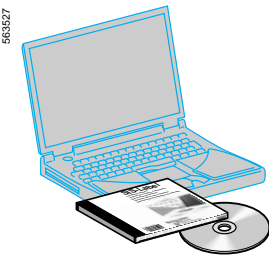

XBY 2U

### Circular legends for Emergency stop mushroom head pushbuttons (yellow)

Diameter mm	Marking on yellow background	Reference	Weight kg
60	Without	ZBY 9101	0.004
	ARRET D'URGENCE	ZBY 9130	0.004
	EMERGENCY STOP	ZBY 9330	0.004
	NOT-AUS	ZBY 9230	0.004
90	Without	ZBY 8101	0.008
	ARRET D'URGENCE	ZBY 8130	0.008
	EMERGENCY STOP	ZBY 8330	0.008
	NOT-AUS	ZBY 8230	0.008



ZBY 9130



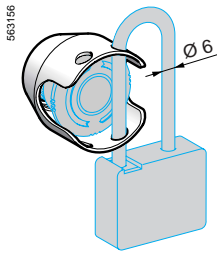
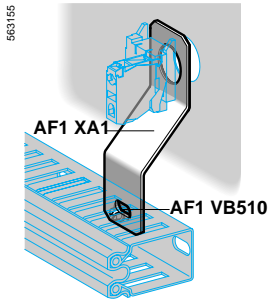

ZBZ 160●

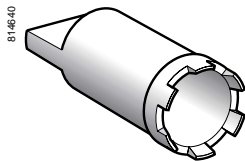

ZB5 AZ905

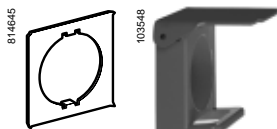

ZB5 AZ902

ZB4 BZ64

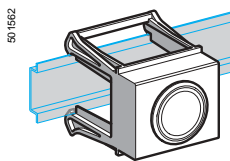

15151

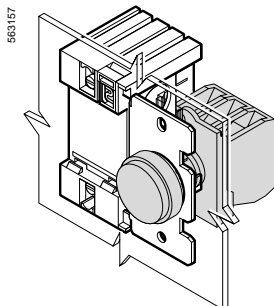

XBZ S43

#### Accessories

Description	Application		Sold in lots of	Unit reference	Weight kg
<b>Cable ducting support</b>	Fixing beneath head		10	AF1 XA1	0.030
<b>M5 x 10 screw, with hexagonal slotted head</b>	For fixing cable ducting		100	AF1 VB510	0.003
<b>Support</b>	For pushbuttons, switches and pilot lights XB5 A		1	DX1 AP52	0.160
<b>Metal guards</b> Padlockable (1)	For Emergency stop function only with the following Ø 40 trigger action pushbuttons: XB5 AT8●, XB5 AS8●, XB5 AS9●, ZB5 AT8●, ZB5 AS8●, ZB5 AS9●.	Chromium plated	1	ZBZ 1600	0.046
		Black	1	ZBZ 1602	0.046
		Red	1	ZBZ 1604	0.046
		Yellow	1	ZBZ 1605	0.046
		Blue	1	ZBZ 1606	0.046
<b>Plastic guard</b>	For selector switches with standard handle or key switches	Black	1	ZBZ 2102	0.005
<b>Plastic blanking plug, round, black (2)</b>	For Ø 22 control and signalling units with circular head		10	ZB5 SZ3	0.008
<b>Plastic blanking plug, square, black (2)</b>	For Ø 22 control and signalling units with square head		10	ZB5 SZ5	0.009
<b>Add-on square trim</b>	Gives a square appearance to ZB5 A circular heads		10	ZB5 AZ31	0.002
<b>Nut</b>	Fixing the head		10	ZB5 AZ901	0.002
<b>Bezel tool</b>	Tightening head fixing nut ZB5 AZ901		1	ZB5 AZ905	0.016
<b>Anti-rotation plate</b>	Prevents rotation of the head		10	ZB5 AZ902	0.008
<b>Padlockable flaps</b>	For pushbuttons	Black	1	ZB4 BZ62	0.076
		Red	1	ZB4 BZ64	0.076
		Yellow	1	ZB4 BZ65	0.076
		Blue	1	ZB4 BZ66	0.076
<b>Pushbutton support</b>	For 35 mm DIN rail, for use in modular enclosure (3)		1	15151	0.040

#### AS-Interface module for Ø 22 control and signalling units

Description	For use with	Unit reference	Weight kg
<b>Panel fixing, in conjunction with a Harmony pushbutton or switch</b>			
<b>S7.F profile</b>	4 inputs and 4 outputs direct supply from the bus	XBZ S43	0.100



(1) No isolation function is possible when this guard is fitted.

(2) Supplied complete with fixing nut.

(3) Marketed under the Merlin Gerin brand.

## BA 9s bulbs and associated accessories

Description	Characteristics	Colour	Sold in lots of	Unit reference	Weight kg
 DL1 CE●●●	≈ 24 V	White	1	DL1 CJ0241	0.002
		Green	1	DL1 CJ0243	0.002
		Red	1	DL1 CJ0244	0.002
		Yellow	1	DL1 CJ0245	0.002
		Blue	1	DL1 CJ0246	0.002
	≈ 48 V	Green	1	DL1 CJ0483	0.002
		Red	1	DL1 CJ0484	0.002
		Yellow	1	DL1 CJ0485	0.002
	6 V -1.2 W	White	1	DL1 CD0061	0.002
		Green	1	DL1 CD0063	0.002
Red		1	DL1 CD0064	0.002	
Yellow		1	DL1 CD0065	0.002	
Incandescent bulbs	6 V -1.2 W	–	10	DL1 CB006	0.002
	24 V - 2 W	–	10	DL1 CE024	0.002
	120...130 V - 2. W	–	10	DL1 CE130	0.002
	Neon bulbs	120...130 V	–	10	DL1 CF110
	230...240 V	–	10	DL1 CF220	0.002
Bulb extractor	–	–	1	XBF X13	0.005
Lens cap tightening tool	Illuminated pushbuttons, with flush push	–	1	ZBZ 8	0.009

## Replacement keys for Emergency stop key release heads and key switches

Description	Key number	Reference	Weight kg
Sets of 2 keys	455	ZBG 455	0.013
	421E	ZBG 421E	0.014
	458A	ZBG 458A	0.014
	520E	ZBG 520E	0.014
	3131A	ZBG 3131A	0.014
	4A185	ZBD A185	0.014
	LU1	ZBD LU1	0.014
	LU2	ZBD LU2	0.014
	LU3	ZBD LU3	0.014
	LU4	ZBD LU4	0.014
	LU5	ZBD LU5	0.014
	LU6	ZBD LU6	0.014
	LU7	ZBD LU7	0.014
	LU8	ZBD LU8	0.014
	LU9	ZBD LU9	0.014
	LU10	ZBD LU10	0.014
	LU11	ZBD LU11	0.014
	LU12	ZBD LU12	0.014
	LU13	ZBD LU13	0.014
LU14	ZBD LU14	0.014	
8D1	ZBD 8D1	0.014	

## Clear boots

Description	For use with pushbuttons	Sold in lots of	Unit reference	Weight kg
Single boots	Flush with circular head	10	ZBP A	0.002
	Projecting with circular head	10	ZBP 0	0.002
	Flush or projecting with circular head for food industry applications	10	ZBP 0A	0.002
Double boots	Flush or projecting double-headed	10	ZBW 008	0.005
	Flush double-headed	10	ZBW 008F	0.005
	Double-headed for food industry applications	10	ZBW 008A	0.005



DL1 CE●●●



DL1 CJ0●●●



DL1 CF●●●

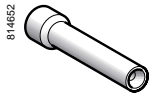

XBF X13

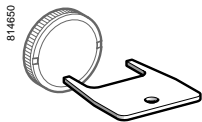

ZBZ 8



ZBG 455

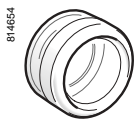

ZBP 0

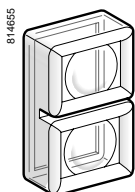

ZBW 008

## Coloured boots

Description	Colour	Sold in lots of	Unit reference	Weight kg
Coloured boots (can be replaced without dismantling the head)	Black	10	ZB2 BP012	0.003
	Green	10	ZB2 BP013	0.003
	Red	10	ZB2 BP014	0.003
	Yellow	10	ZB2 BP015	0.003
	Blue	10	ZB2 BP016	0.003

## Lens caps

For use with	Colour	Sold in lots of	Unit reference	Weight kg
--------------	--------	-----------------	----------------	-----------

## Circular lens caps for light sources with integral LED

Pilot lights	White	10	ZBV 0113	0.002
	Green	10	ZBV 0133	0.002
	Red	10	ZBV 0143	0.002
	Yellow	10	ZBV 0153	0.002
	Blue	10	ZBV 0163	0.002
	5 different coloured grooved lenses (1)	1	ZBV 0103S	0.010
Illuminated pushbuttons, with flush push	White	10	ZBW 9113	0.002
	Green	10	ZBW 9133	0.002
	Red	10	ZBW 9143	0.002
	Yellow	10	ZBW 9153	0.002
	Blue	10	ZBW 9163	0.002
Illuminated pushbuttons, with projecting push	White	10	ZBW 9313	0.002
	Green	10	ZBW 9333	0.002
	Red	10	ZBW 9343	0.002
	Yellow	10	ZBW 9353	0.002
	Blue	10	ZBW 9363	0.002

## Square lens caps for light sources with integral LED

Pilot lights	White	10	ZBC V0113	0.002
	Green	10	ZBC V0133	0.002
	Red	10	ZBC V0143	0.002
	Yellow	10	ZBC V0153	0.002
	Blue	10	ZBC V0163	0.002
Illuminated pushbuttons, with flush push	White	10	ZBC W9113	0.002
	Green	10	ZBC W9133	0.002
	Red	10	ZBC W9143	0.002
	Yellow	10	ZBC W9153	0.002
	Blue	10	ZBC W9163	0.002
Illuminated pushbuttons, with projecting push	White	10	ZBC W9313	0.002
	Green	10	ZBC W9333	0.002
	Red	10	ZBC W9343	0.002
	Yellow	10	ZBC W9353	0.002
	Blue	10	ZBC W9363	0.002

## Circular lens caps for light sources with BA 9s base fitting

Pilot lights	White	10	ZBV 011	0.002
	Green	10	ZBV 013	0.002
	Red	10	ZBV 014	0.002
	Yellow	10	ZBV 015	0.002
	Blue	10	ZBV 016	0.002
	Clear	10	ZBV 017	0.002
	Illuminated pushbuttons, with flush push	White	10	ZBW 911
Green		10	ZBW 913	0.002
Red		10	ZBW 914	0.002
Yellow		10	ZBW 915	0.002
Blue		10	ZBW 916	0.002
Clear		10	ZBW 917	0.002
Illuminated pushbuttons, with projecting push	White	10	ZBW 931	0.002
	Green	10	ZBW 933	0.002
	Red	10	ZBW 934	0.002
	Yellow	10	ZBW 935	0.002
	Blue	10	ZBW 936	0.002
	Clear	10	ZBW 937	0.002

(1) Clear, green, red, yellow, blue.



ZBV 0103



ZBV 010

### Pilot lights

<b>Integral LED</b> XB5 AVB●, AVG●, AVM●	<b>Direct supply</b> XB5 AV6	<b>Via integral transformer</b> XB5 AV3●, AV4●	Common face view
---	---------------------------------	---	------------------

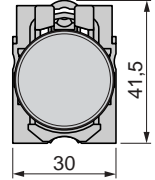
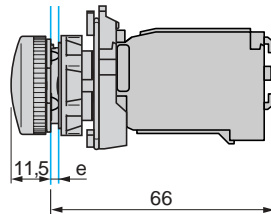
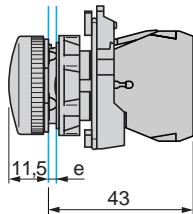
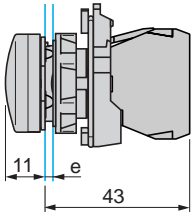

e: panel thickness: 1 to 6 mm

### Illuminated pushbuttons

<b>Integral LED</b> XB5 AW3●●5	<b>Direct supply</b> XB5 AW3●65	<b>Via integral transformer</b> XB5 AW3●●5	Common face view
-----------------------------------	------------------------------------	---	------------------

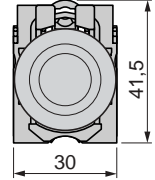
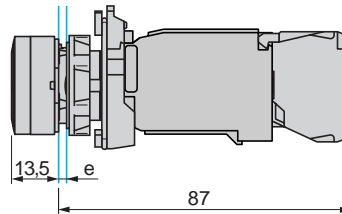
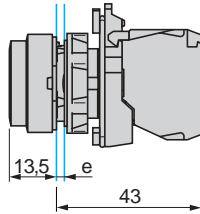
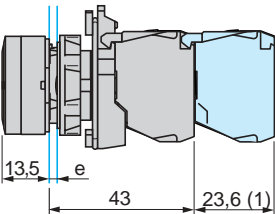

(1) Additional row of contacts or double contact.

### Double-headed pushbuttons with pilot light

<b>Integral LED</b> XB5 AW84●5
-----------------------------------

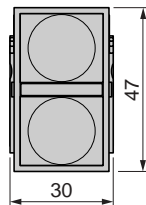
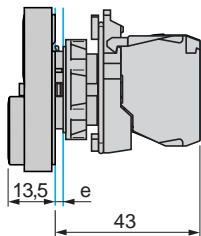

e: panel thickness: 1 to 6 mm

### Illuminated selector switches

<b>Integral LED</b> XB5 AK12●●5
------------------------------------

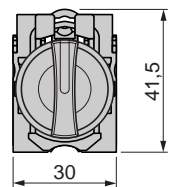
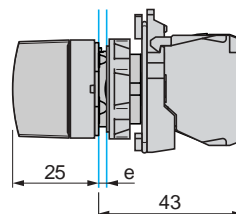

### Panel cut-out for pushbuttons, switches and pilot lights (2)

<b>Screw clamp terminal and plug-in connector models</b>	<b>Printed circuit board connection models</b>	<b>Detail of lug recess</b>
--	--	-----------------------------

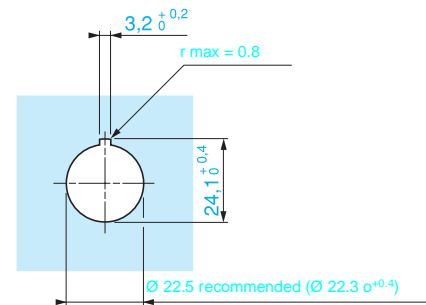
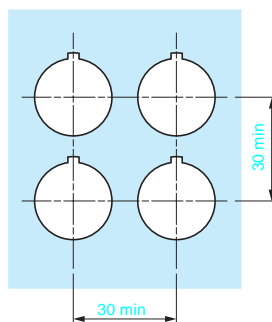
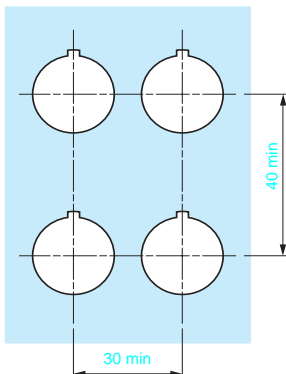

(2) Fixing centres for pushbuttons, switches and pilot lights fitted with Faston connector terminals 32 x 45 min.

### Pushbuttons, spring return

**XB5 AA●●**

**XB5 AL●●**

Common face view

**XB5 AP●●**

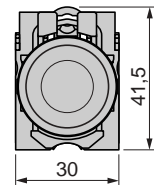
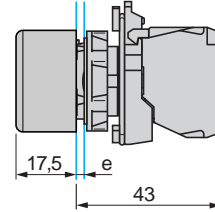
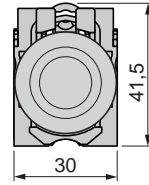
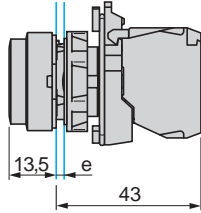
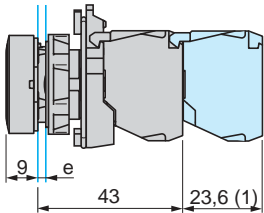

(1) Additional row of contacts or double contact.

### Mushroom head

**XB5 AC21**

### Double-headed

**XB5 AL●45, AL●4C5**

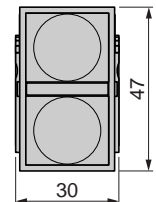
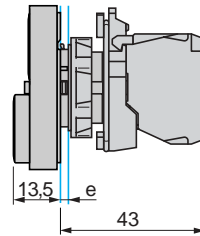
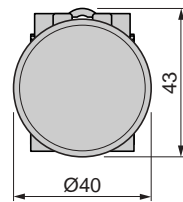
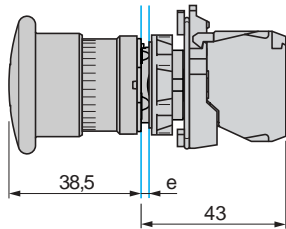

e: panel thickness: 1 to 6 mm

### Emergency stop mushroom head pushbuttons

**XB5 AT42, BT845**

**XB5 AS542, AS8445**

**XB5 AS142, A 9445**

Common face view

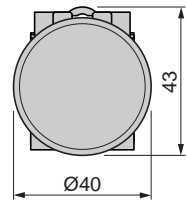
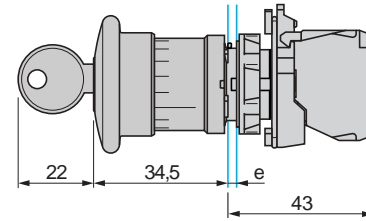
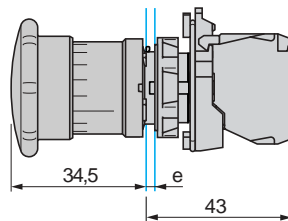
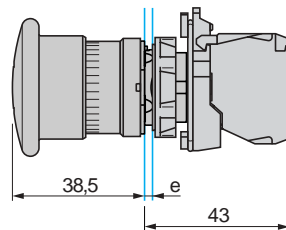

e: panel thickness: 1 to 6 mm

### Selector switches

#### Standard handle operator

**XB5 AD**

#### Long handle operator

**XB5 AJ**

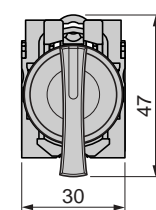
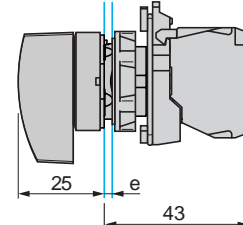
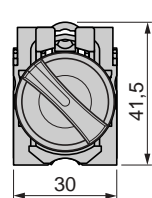
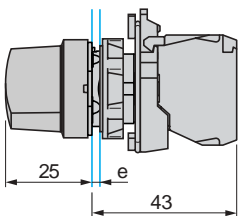

### Key switches

**XB5 AG**

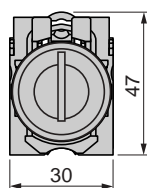
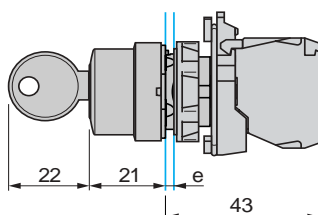

e: panel thickness: 1 to 6 mm

# Control and signalling units Ø 22

## Harmony® style 5

Pushbuttons, switches and pilot lights with double insulated bezel

Complete units ZB5 A : contact functions

### Heads for spring return pushbuttons

ZB5 AA●, AA●●●, ZB5 AA●8

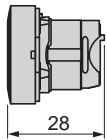

ZB5 AL●, AL●●●

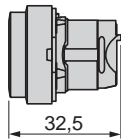

ZB5 AA●4, AA●6

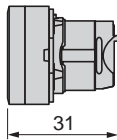

Common face view

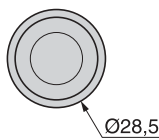

ZB5 AP●● ZB5 AP●S

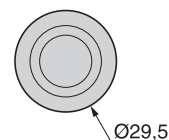
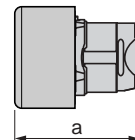

ZB5 CA●, CA0

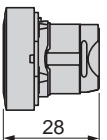

ZB5 CL●

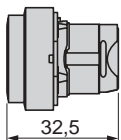

Common face view

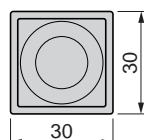

ZB4	a
AP●●	36,5
AP●S	33

### Heads for pushbuttons

Lockable "push-turn"

ZB5 AFD

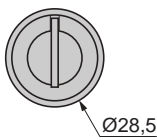
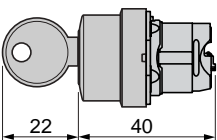

Push-push to release

ZB5 AH0●

ZB5 AH●

Common face view

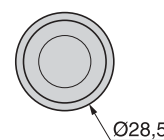
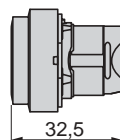
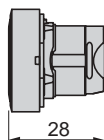

ZB5 CH0●

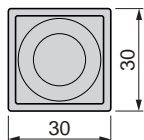
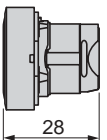

### Heads for double-headed, spring return pushbuttons

ZB5 AA81●●, ZB5 AA82●●

ZB5 AL83●●, ZB5 AL84●●

Common face view

ZB5 AA91●●, ZB5 AA92●●

ZB5 AL93●●, ZB5 AL94●●

Common face view

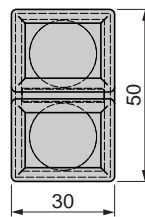
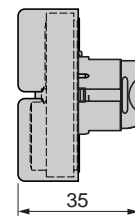
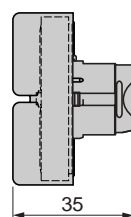
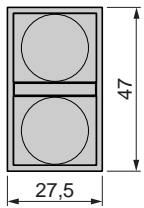
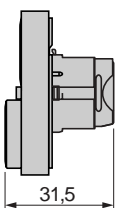
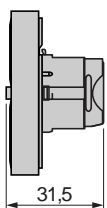

### Heads for pushbuttons

Mushroom head

ZB5 AC●4

ZB5 AC●, AR●

ZB5 AR●16

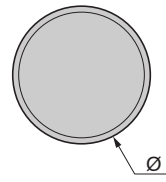
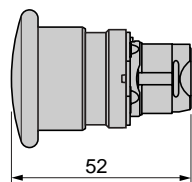
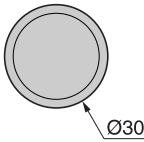
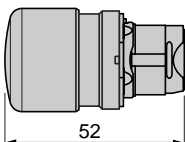

ZB5	Ø
AC●	40
AR●	60

### Mushroom heads for latching pushbuttons

#### Push-pull

ZB5 AT44

ZB5 AT4, AT84, AX4

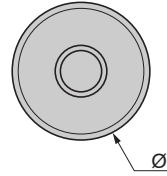
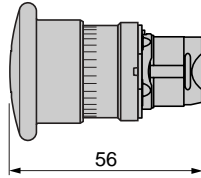
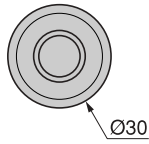
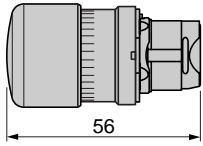

ZB5	Ø
AT4, AT84	40
AX4	60

#### Turn to release

ZB5 AS4●, AS834

ZB5 AS5●, AS844, AS6●

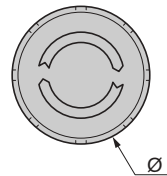
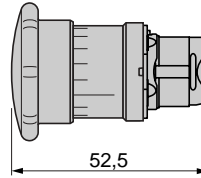
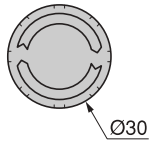
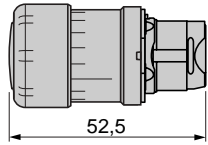

ZB5	Ø
AS5●, AS844	40
AS6●	60

#### Key release

ZB5 AS7●, AS934

ZB5 AS1●, AS2●, AS944, AS964

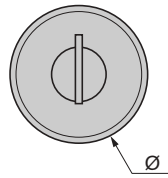
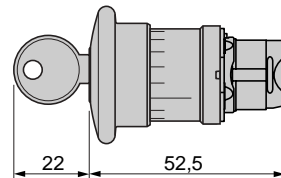
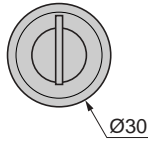
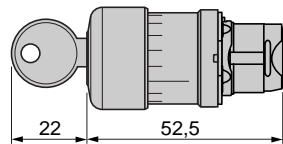

ZB5	Ø
AS1●, AS944	40
AS2●, AS964	60

ZB5 AS14D

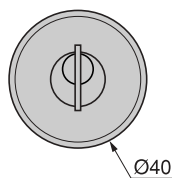
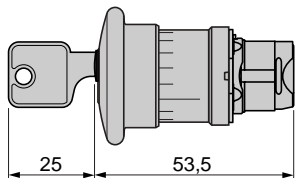

### Heads for selector switches

#### Standard handle operator

ZB5 AD●, AD●M

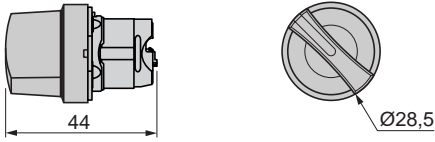

#### Long handle operator

ZB5 AJ●, AJ●M

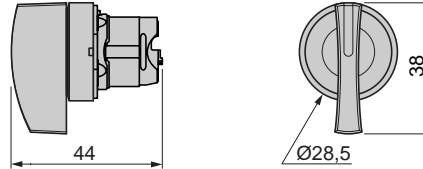

#### Knurled knob, black

ZB5 AD●9

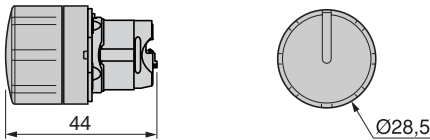

#### Key switch (Ronis n° 455)

ZB5 AG●, AG0●, AG●M

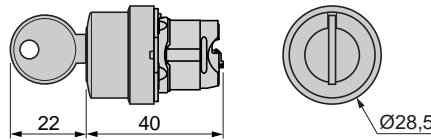

#### Key switch (DOM n° 8D1)

ZB5 AGD

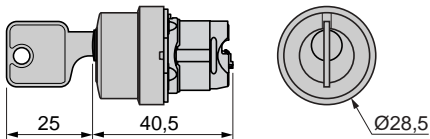

### Heads for toggle switches

ZB5 AD●8

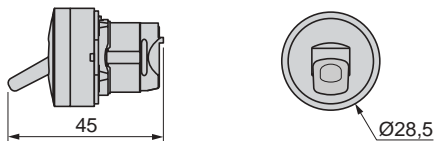

### Bodies for pushbuttons and switches

#### Screw clamp terminal connections

ZB5 AZ10●, AZ141

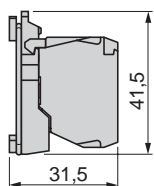

#### Plug-in connector

ZB5 AZ10●4, AZ1414

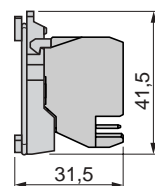

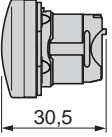
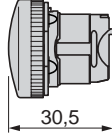
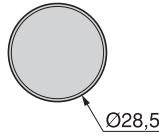
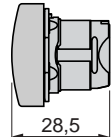
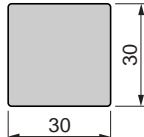

### Heads for pilot lights, with light source

Integral LED	Incandescent, neon or LED		ZB5 CV0●3, CH3●3
ZB5 AV0●3	ZB5 AV0●, AV0●S	Common face view	
			
30,5	30,5	Ø28,5	28,5
			
			30

### Bodies for pilot lights, screw clamp terminal connections

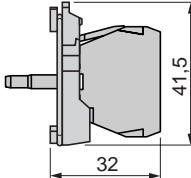
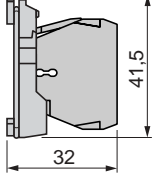
Integral LED	Direct supply, for BA 9s bulb	Via integral transformer for BA 9s bulb
ZB5 AV●●	ZB5 AV6	ZB5 AV●, AV●D●
		
41,5	41,5	41,5
32	32	55

### Bodies for pilot lights, plug-in connector

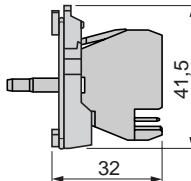
Integral LED
ZB5 AV●●4

41,5
32

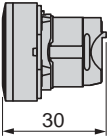
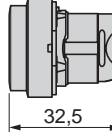
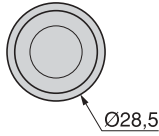
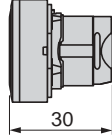
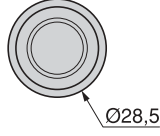
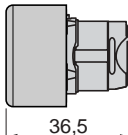
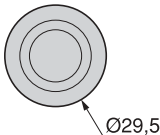
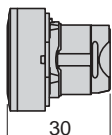
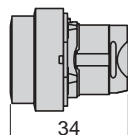
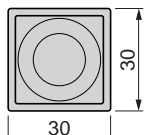
### Heads for spring return illuminated pushbuttons, for light source

LED	Common face view		ZB5 AW9●3	Common face view
ZB5 AW3●3, AW3●3S, ZB5 AA●8	ZB5 AW1●3, ZB5 AL●8			
				
30	32,5	Ø28,5	30	Ø28,5
ZB5 AW5●3	ZB5 CW3●3	ZB5 CW1●3	Common face view	
				
36,5	Ø29,5	30	34	30
				30

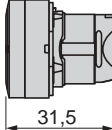
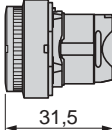
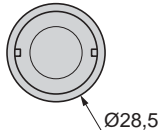
### BA 9Ss bulb

ZB5 AW3●, AW3●S	ZB5 AW1●	Common face view
		
31,5	31,5	Ø28,5

# Control and signalling units Ø 22

## Harmony® style 5

Pushbuttons, switches and pilot lights with double insulated bezel

Complete units ZB5 A : signalling functions with or without contacts

### Heads for double-headed pushbuttons with pilot light

ZB5 AW81●●●3, ZB5 AW82●●●3	ZB5 AW83●●●3, ZB5 AW84●●●3	Common face view
31,5	31,5	47 27,5

### Mushroom heads for latching pushbuttons

ZB5 AW7●3	
49,5	Ø40

### Heads for illuminated "push-push to release" pushbuttons

ZB5 AH0●3	ZB5 AH●3	Common face view
30	32,5	Ø28,5

### Heads for illuminated selector switches with standard handle

ZB5 AK1●●3	
42,5	Ø28,5

### Bodies for illuminated pushbuttons and selector switches, screw clamp terminal connections

Integral LED	Direct supply, for BA 9s bulb	Via integral transformer for BA 9s bulb
ZB5 AW0●●●	ZB5 AW06●	ZB5 AW0●●, AW0●D●●
23 31,5	23 31,5	41,5 43,5 23 75

### Bodies for illuminated push-buttons/switches, plug-in connector Integral LED

ZB5 AW0●●●4
31,5

### Manual overload reset buttons

XB5 A8●●●	XB5 AL8●●●	Common face view
18 e (1)	22,5 e (1)	Ø28,5

### Head + mounting base for potentiometer

ZB5 AD9●2	
27	Ø28,5

(1) Value not yet available

### Joystick controllers

XD5 PA●2	XD5 PA●4	Common face view
66 108 e 23	66 132 e 47	47 30

e: panel thickness 1 to 6 mm

### Hour counters

XB5 DS●	
11,5 e 60	30 30

### Annunciators

XB5 KS●	
11 e 59,7	30 30

### Connection diagram

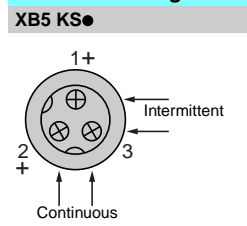

### Pushbuttons, switches and pilot lights for printed circuit board connection

#### Panel cut-out (viewed from installer's side)

Dimensions in mm

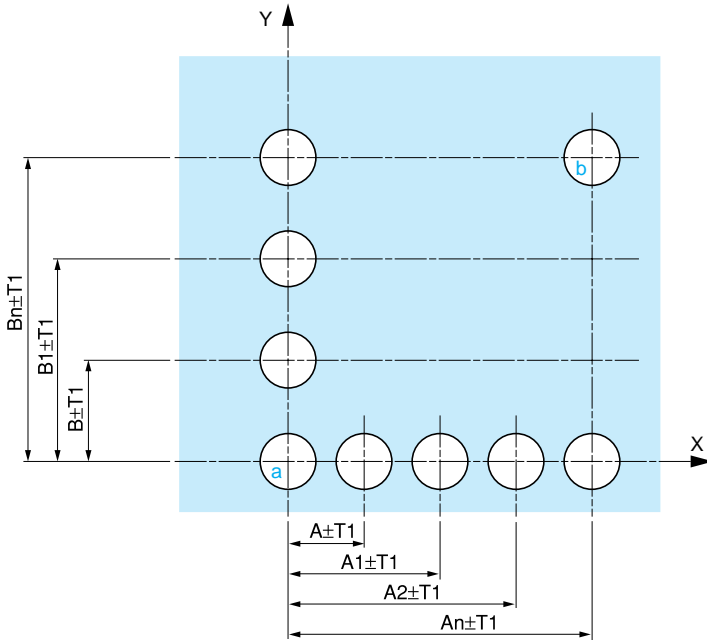

#### Printed circuit board drillings (viewed from electrical block side)

Dimensions in mm

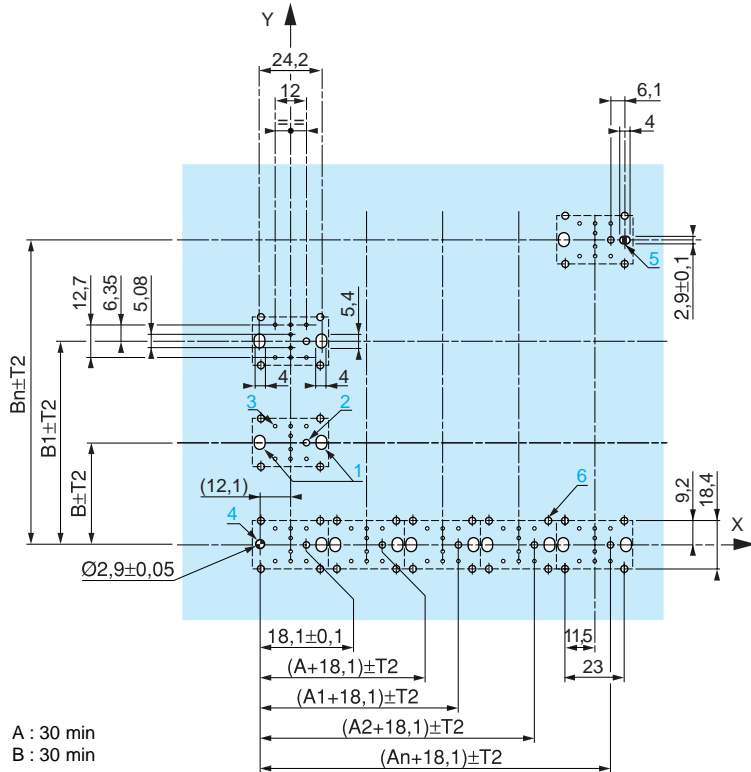

A : 30 min  
B : 30 min

#### General tolerances of the panel and printed circuit board

The cumulative tolerance must not exceed 0.3 mm: T1 + T2 = 0.3 mm max.

#### Installation precautions:

Minimum thickness of circuit board: 1.6 mm.

Cut-out diameter: 22.5 mm ± 0.1 mm.

Orientation of body/fixing collar ZB5 BZ079: ± 2 ° 30' (excluding cut-outs marked **a** and **b**).

Tightening torque of screws ZBZ 006: 0.6 N.m.

Allow for one ZB5 BZ079 pillar and its fixing screws:  
- every 90 mm horizontally (X) and every 120 mm vertically Y,  
- with each selector switch head (ZB5 AD●, ZB5 AJ●, ZB5 AG●).

The fixing centres marked **a** and **b** are diagonally opposed and must align with those marked **4** and **5** on the printed circuit board.

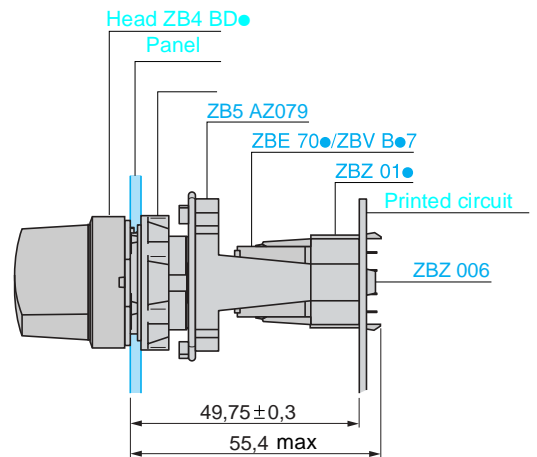

#### Mounting of adaptor (socket) ZBZ 01● :

- 1 2 elongated holes for ZBZ 006 screw access.
- 2 1 hole Ø 2.4 mm ± 0.05 for centring adaptor ZBZ 01●.
- 3 8 x Ø 1.2 mm holes.
- 4 1 hole Ø 2.9 mm ± 0.05, for centring the printed circuit board (with cut-out marked **a**).
- 5 1 elongated hole for orientation of the printed circuit board (with cut-out marked **b**).
- 6 4 holes Ø 2.4 mm ± 0.05 for clipping in adaptor ZBZ 01●.

Dimensions An + 18.1 relate to the Ø 2.4 mm ± 0.05 holes for centring adaptor ZBZ 01●.

**Schneider Electric Industries SAS**

**Headquarters**

89, bd Franklin Roosevelt  
F - 92506 Rueil Malmaison Cedex

<http://www.schneider-electric.com>

Owing to changes in standards and equipment, the characteristics given in the text and images in this document are not binding until they have been confirmed with us.

Production : Schneider Electric Industries  
Photos : Schneider Electric Industries  
Printed by : CCI



April 2004